



**Electrical
Safety** First

Powering change +
saving lives.

BATTERY BREAKDOWN

WHY ARE E-SCOOTER AND E-BIKE
BATTERIES EXPLODING IN PEOPLE'S
HOMES AND WHAT CAN BE DONE ABOUT IT?



A report into the increase in lithium-ion battery fires
and recommendations for addressing the problem





CONTENTS

EXECUTIVE SUMMARY The electrical safety of e-bikes and e-scooters (e-micromobility)	4
1.0 Introduction	8
1.1 The Drive to Net Zero	11
1.2 Scope	12
2.0 Safety Concerns	14
2.1 Conversion Kits and Modifications	18
2.2 Dangerous Compatibility of Chargers and Battery Voltages	23
2.3 Fatally Flawed Design	26
2.4 Disposal of Lithium-ion Batteries	30
3.0 Legislation and Standards	33
4.0 Shared e-micromobility in the UK	39
5.0 Our Investigations	43
6.0 Strategies to Mitigate Fire Risk	45
SUMMARY OF RECOMMENDATIONS	48
ANNEX A Media reports	51
BIBLIOGRAPHY	54

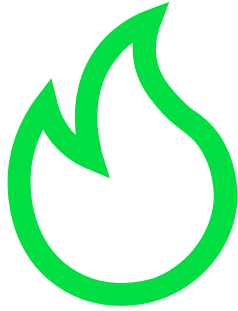



Electrical Safety First

Powering change + saving lives.



ABOUT ELECTRICAL SAFETY FIRST

Electrical Safety First is a campaigning charity that aims to reduce deaths and injuries caused by electricity in UK homes. We do this by working closely with Government, the electrical industry, manufacturers, retailers and consumer safety organisations to improve safety regulation and standards. We run media and digital campaigns to share advice and guidance with consumers that will help them to stay safe in their homes.

EXECUTIVE SUMMARY

The electrical safety of e-bikes and e-scooters (e-micromobility)



Rise in fires caused by e-bikes and e-scooters

There is growing concern over the rise in fatalities, injuries and devastating fires from electric bikes (e-bikes) and electric scooters (e-scooters). Tragically, in the first three months of 2023 alone, fires from lithium-ion batteries used to power these devices had already taken four lives in the UK, left others hospitalised or seriously injured and caused extensive damage to property.

The London Fire Brigade (LFB) describes lithium-ion battery fires as the capital’s fastest emerging and growing fire risk.

Currently, there is limited data relating to the number of fires in the UK, mainly due to deficiencies in the national Incident Recording System (IRS). However, the LFB has reported attending 87 e-bike and 29 e-scooter fires across Greater London in 2022. In the first half of 2023, on average, the LFB has been called to an e-bike or e-scooter fire once every two days – a 60% increase in the number of these fires compared to the same period last year. Fire data recorded regionally is not mandatory. In order to gain a true national picture of the issue, the IRS used by all services across the country must be improved.

The UK is not alone when it comes to the devastating consequences of lithium-ion battery fires. In New York City, fire officials reported five fatalities in the first four months of 2023 from e-bike and e-scooter lithium-ion battery fires. As a result, the city authorities have taken decisive regulatory action.

What is the danger?

The primary risk associated with lithium-ion batteries is thermal runaway. Battery safety and stability depend on maintaining internal temperatures within specific limits.

Poor quality and substandard components, flawed design, physical abuse and improper charging

WHAT IS THERMAL RUNAWAY?

The process of **thermal runaway** starts when a battery cell overheats, perhaps due to an internal fault, physical or electrical abuse, or extreme temperatures. This elevated cell temperature results in exothermic reactions, which produce more heat than can be dissipated to surroundings. Eventually the internal structure of the cell begins to become unstable and collapse, resulting in the venting of flammable and toxic gases, fire and explosion. The heat spreads to nearby cells, causing them also to enter an uncontrollable and irreversible state of thermal runaway.

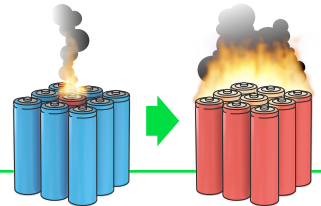

or discharging can all cause a battery to become thermally unstable and can lead to catastrophic failure. Even if a fire is extinguished, it is common for the fire to start again, highlighting the dynamic nature of lithium-ion battery fires.

Such is the concern about the risk of fire and toxic smoke release posed by e-scooters that a number of major transport operators across the UK have now banned e-scooters. At the time of this research, 16 operators have bans in place that, in many cases, extend to similar machines, including e-hoverboards, e-unicycles and e-skateboards (Figure 1).

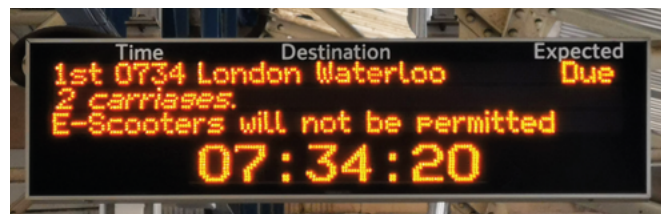

Figure 1: Example of train station display warning e-scooters not permitted.



Figure 2: Photos of test sample during a thermal runaway event after being incorrectly charged.

Isolated incidences or systemic failings?

As e-micromobility becomes more popular, the number of reported incidents is bound to rise, due to the increased use. The question is, should they be regarded as ill-fated isolated incidents? Or do similarities in circumstances indicate systemic failings?

A number of factors can contribute to mitigating the risk of fires and other incidents: improving the public's understanding of risk, safety in design, production control, supply chain due diligence, safety standards and an effective legislative framework. Shortcomings in any of these areas need to be identified and addressed to ensure a high level of protection for consumers that is proportionate to the risk.

THIS REPORT

This report outlines the findings of our research into the safety of e-bikes and e-scooters, and sets out recommendations for improving safety. Through desktop and investigative research, we look at the current regulatory landscape and explore various aspects of e-micromobility manufacturing, supply and use, to better understand the causes and types of failure that have, in some instances, tragically resulted in fatalities and serious injury.

This report concentrates mainly on e-bikes, categorised as electrically assisted pedal cycles (EAPC) and e-scooters. It also includes powered cycles such as L-Category Vehicles (L1e-A) up to and including 1000 watts, due to their similarity with EAPCs, and conventional cycles which have been converted to an e-bike using a conversion kit.

Media coverage

Analysis of UK media coverage concerning fires from e-scooters and e-bikes has revealed an alarming rise in the number of reported fires and identified some of the key factors that may have influenced the overall trends in fire-related incidents.

Reports indicate that there is a serious safety risk with e-bikes being stored or charged in certain residential locations, such as emergency fire exit routes. As half of the fires occurred overnight, the risk to life and catastrophic property damage significantly increases when the e-bike or e-scooter has been left charging unattended, whilst the owner is asleep.

Conversion kits and DIY modifications

Warnings have been issued about fires from e-bikes that have been converted – predominantly from conversion kits – and batteries purchased from online marketplaces, which may not meet the correct safety standards. Anecdotal evidence also suggests that DIY modifications to the electrical systems (to prolong battery life and increase speed) and other risky practices are being promoted through online channels. Public perception that these practices are low risk need to be countered through consumer education.

Mis-selling and online marketplaces

Complex laws around the sale and use of different types of e-micromobility are being exploited by some sellers and riders. As a result, some mis-selling practices result in purchases of e-bikes that break the EAPC rules for road use and private e-scooters being ridden illegally on city streets. Third-party sellers through online marketplaces are also profiteering from the sale of unbranded “universal” chargers for lithium-ion batteries, which can result in overcharging at higher voltages than intended. Tests carried out by Electrical Safety First (ESF) at BRE's laboratories, to simulate foreseeable use of a universal charger, resulted in fire and explosions (Figure 2).

In a separate investigation, ESF found almost 60 listings of substandard e-bike and e-scooter chargers for sale through third-party sellers. These unsafe chargers were identified solely through images of non-compliant mains plugs included in the listing. A non-compliant plug is a sign that the charger has not been adequately tested to the necessary safety standards, and a discerning indication that further hidden dangers may exist.

Product design

Scooter design has been around for over 100 years, but with the addition of assisted power, in the shape of a motor, the design now needs to take account of additional components and stresses not originally foreseen. As with e-bikes, the position of the battery, ingress protection (preventing water entering the battery) and other aspects of construction need to be considered to maintain safety. Future legislation specifying minimum technical requirements should consider the design recommendations in this report.

Inconsistent standards

Manufacturers can use safety standards for ready-built e-bikes and e-scooters to demonstrate conformity to safety regulations. However, standards developed by different technical committees have resulted in inconsistencies in requirements, which can lead to legal uncertainty. If feasible and desirable, a standard needs to be developed for conversion kits – an area left currently unregulated. The UK Government should undertake a review of published standards to identify gaps and establish a robust safety framework.

Disposal challenges and opportunities

Aside from the consequences of environmental contamination when they end up in landfill, lithium-ion batteries cause 201 waste fires in the UK every year (around 48% of all waste fires), costing around £158m annually.¹

Consumer awareness and recycling initiatives have been proposed as solutions. Accessibility to recycling facilities, clearer instructions and more prominent markings on batteries need to be considered.



E-micromobility share schemes

Many local authorities have already made notable progress in establishing shared micromobility schemes that provide rental services for e-bikes, e-scooters (as part of government trials) and cargo bikes. The e-scooter trials can offer a lot of valuable information to inform future regulation for private e-scooters, but more rigorous data needs to be captured from the trials and more objective measures set to evaluate safety aspects.

The road to safety

Irrespective of any future restrictions on use, e-micromobility is here to stay. Research carried out by Mintel² suggests that the UK e-bike market is now worth over £300 million, with around 90% of e-bike sales being hybrid/city bikes or mountain bikes. E-scooters too have seen a strong increase in sales: in 2021, an estimated 175,000 e-scooters were sold. The e-scooter market reached an estimated £50 million, despite uncertainty over legalisation holding back growth.

There is no silver bullet solution to resolving the safety issues surrounding e-micromobility. In the UK, these issues must be addressed by a range of stakeholders, including industry, government and regulatory bodies, public services, standards committees, campaigning bodies, delivery firms and their riders.

We have much to learn from the solutions adopted in other countries. For example, the regulatory reform taking place in New York, requiring third-party mandatory certification of e-bikes and e-scooters, and the imminent partial ban of certain types of e-scooters in Paris, both demonstrate that no proposed solution should be dismissed out of hand.

SOURCES

¹ <https://www.eunomia.co.uk/lithium-ion-battery-waste-fires-costing-the-uk-over-100m-a-year/>

² <https://store.mintel.com/report/e-mobility-electric-bikes-and-scooters-uk-2022>

Technological advances in battery design are being accelerated to improve safety in other sectors that could be stipulated for use in accident-prone e-micromobility products.

We hope that this report helps to bring to light some of the challenges and opportunities in making e-micromobility safer.

We must work together to ensure that consumers understand the risks and make informed decisions. Consumer engagement is a central theme throughout the report and an area in which we believe ESF has a key role to play.

Our recommendations are summarised here:

[READ OUR RECOMMENDATIONS](#)

⋮ **” We must work together to ensure that consumers understand the risks and make informed decisions. As such, consumer engagement is a central theme throughout the report and an area in which we believe Electrical Safety First has a key role to play.**





Electrified forms of micromobility are increasingly recognised as an effective mode of urban transport. They have the potential to reduce private and commercial vehicle use for short-distance travel and help reduce our dependence on fossil fuels.

This report outlines the findings of our research into the safety of electrified micromobility vehicles (e-micromobility), specifically e-bikes and e-scooters, as defined in the scope of this report, with particular emphasis on the associated electrical safety aspects. We also explore the challenges faced by both manufacturers of e-micromobility products and authorities responsible for regulating consumer product safety in this sector.

As e-micromobility products have become more popular, serious safety issues relating to their use have come to light. When the batteries powering these products fail, they often release a huge amount of energy – rather like a firework. This release of energy is known as thermal runaway; it releases toxic gases and can cause ferocious fires.

This report explores aspects of e-micromobility design, manufacture and use, to better understand the causes and types of failure that have, in some instances, tragically resulted in fatalities and serious injury. The report also sets out recommendations for improving safety.

The rise of e-micromobility

E-micromobility offers significant and novel opportunities to reduce emissions and congestion, as well as helping to improve accessibility in cities across the world.

E-bikes can now be seen in every town and have become an integral part of everyday city life. They are shaping our city landscapes and are considered a breakthrough in personal mobility. As well as providing a convenient and cost-effective means of transport, they can improve mobility for people who would

not otherwise contemplate cycling – particularly in hilly areas – or who have difficulty cycling, for health or other reasons. E-micromobility can also provide an alternative mode of transport in areas that are underserved by public transport, or outside normal hours.

Economic factors are also making e-micromobility more popular. Shimano's 'State of the Nation 2022 report'³ reveals that, across all 12 European countries profiled, of those surveyed, cost of living (for example, higher car fuel prices) is the primary motivating factor (47%) in e-bike usage now, compared to one year ago. In the UK, this number rises to 56%.

Research carried out by Mintel⁴ discovered that the e-bike market value had risen almost fivefold over the past five years, with e-bikes sales having plateaued after the COVID surge in 2020. By 2022, Mintel suggest that the UK market is now worth over £300 million, with around 90% of e-bike sales being hybrid/city bikes or mountain bikes. E-scooters have also seen strong increases in sales.

SOURCES

³ https://lifestylebike.shimano.com/_assets/images/stories/2022/state-of-the-nation/shimano-state-of-the-nation-2022.pdf

⁴ <https://store.mintel.com/report/e-mobility-electric-bikes-and-scooters-uk-2022>

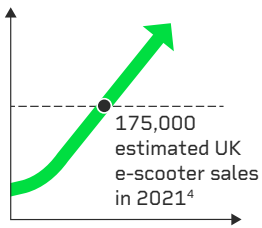

In 2021, there were an estimated 175,000 e-scooters sold, with the market reaching an estimated £50 million, despite uncertainty over legalisation to permit privately-owned e-scooters on public roads, which is holding back growth.

History

Back in 1895, the first bikes fitted with batteries and electric motors were patented (Figure 3). However, primarily due to the combination of weight and low range, these early bikes never caught on. The situation changed in 1991, with the introduction of lithium-ion batteries. Today, one battery charge on an e-bike can potentially cover over 60 miles. Lithium-ion batteries became affordable thanks to the mass production of laptops, mobile phones and other portable devices powered by these batteries.⁵

Research by Mintel highlights that 5% of adults and 14% of cyclists in the UK say they're "likely" to buy an e-bike over the next 12 months; this amounts to about 2.78 million people. In 2015, only a few thousand e-bikes were sold in the UK; by 2018, the number had risen to 70,000. There is every reason to expect sales to continue to grow.⁶

What is an e-bike?

E-bikes are capable of doing just about everything a regular bike can do, and more. In the UK (and Europe), e-bikes are categorised based on their design and performance. Terms like 'e-bike', 'electrically assisted pedal cycle', 'pedelecs' and 'powered cycle' all appear to describe the same type of electric bike, so you could be forgiven for believing that these terms are interchangeable. In fact, each term indicates a subtle difference in the status of the vehicle, and the legal implications of its use.

An electrically assisted pedal cycle (EAPC) is essentially a pedal bike assisted by a motor. It looks like a standard pedal cycle but includes a rechargeable battery, which is either integrated into the bike frame or detachable, and a motor to assist with the pedalling. The rider can choose to pedal unassisted or engage the motor and battery so that the motor takes some of the strain. The motor cuts out once the bike reaches a top speed of 15.5 miles per hour. The rider

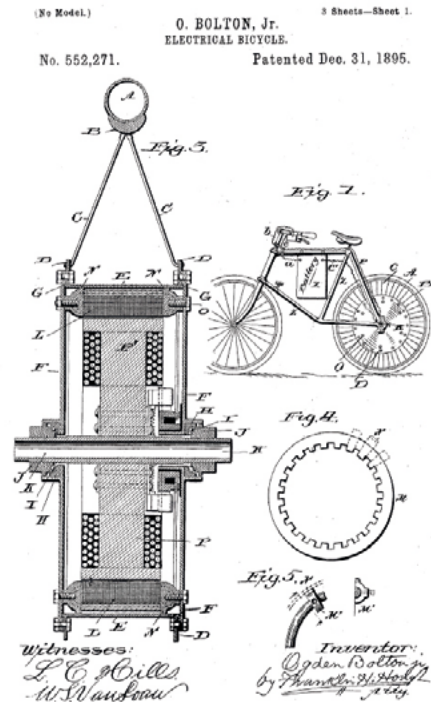

Figure 3: Extract from US Patent 552,271.

is able to exceed 15.5 miles per hour, but without the help of the motor.

As long as the rider is at least 14 years old and the electric bike meets the EAPC requirements, it is treated in law exactly the same as a standard bicycle. You do not need a licence to ride one and it does not need to be registered, taxed or insured.⁷ It is also worth noting that, although the term 'bicycle' suggests a vehicle with two wheels, vehicles with more than two wheels, such as tricycles, may also be classified as EAPCs.

Any e-bike that over-steps the EAPC rules is classed as a motorcycle or moped, and needs to be registered, taxed and insured. You will need a driving licence to ride one and you must wear a motorcycle helmet.

SOURCES

⁵ <https://www.bosch-ebike.com/en/everything-about-the-ebike/stories/200-years-of-bicycle-history>

⁶ <https://www.mintel.com/press-centre/on-your-e-bike-14-of-uk-cyclists-intend-to-buy-an-e-bike-in-the-next-year/>

⁷ <https://www.gov.uk/electric-bike-rules>



E-bike motors

E-bike motors are located in one of two areas; in the crank drive or the wheel hubs (Figure 4). Crank drive motors are generally regarded as most popular because they drive the chain to maintain their power over a range of speeds and tend to be more powerful. Wheel hub motors still have a place for budget-minded riders.

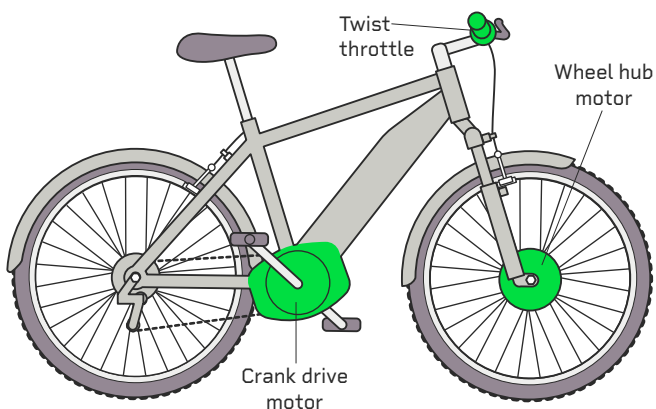

Figure 4: E-bike motors.

Speed pedelecs and 'twist and go' e-bikes

Speed pedelecs are similar to EAPCs. They are pedal assisted but have more powerful motors, and are therefore classified in the UK as mopeds or motorcycles. 'Twist and go' e-bikes are e-bikes with a throttle, allowing the rider to obtain extra power even when not pedalling. In the UK, this type of e-bike is treated as a moped or motorcycle regardless of the power of the motor, although since 2016 there is an exemption for e-bikes where throttle power is available only up to 3.7 miles per hour (6 kilometres per hour) without pedalling, to help moving off from a stationary position.

E-scooters

E-scooters resemble a standard two-wheeled kick scooter from the 1990s. They differ in that they have been fitted with rechargeable batteries and a motor to make them self-propelled. Most e-scooters are designed to be ridden standing upright with both hands on the handlebar, although some scooters are supplied with optional accessories, allowing them to be converted into seated electric scooters. Their speed is controlled with acceleration and braking functions on the handlebar, also known as 'twist and go'.

E-scooters are officially defined as powered transporters or Personal Light Electric Vehicles (PLEVs) in the UK and are treated as motor vehicles in UK law,⁸ effectively rendering them illegal for use on public highways and spaces.

The UK Government is currently running trials of e-scooters within local authority areas to gather data to inform future policy and legislation. The e-scooters being used in the trials are limited by law to a maximum of 15.5 miles per hour, with some regional variations that lower the top speed. Trial e-scooters can be used on the road (except motorways) and in cycle lanes, but not on the pavement.

SOURCE

⁸ <https://www.gov.uk/government/publications/power-transporters/information-sheet-guidance-on-powered-transporters>



1.1 THE DRIVE TO NET ZERO

In 2019, legislation was passed requiring the UK Government to reduce greenhouse gas (GHG) emissions to net zero by 2050, relative to 1990 levels.⁹ Separate targets exist across the devolved administrations (DAs); the Welsh Government recently committed to a 2050 net zero target¹⁰ and the Scottish Government has a more ambitious target to achieve net zero by 2045.¹¹ Northern Ireland’s goal is also 2050, which was set out in the Climate Change Act (Northern Ireland) 2022.¹²

24% of global direct carbon dioxide (CO₂) emissions from fuel combustion is attributable to transport and this figure continues to rise annually. Transport in the UK is also responsible for more CO₂ emissions than any other sector, comprising 24% of the total (113 MtCO₂, not including international aviation and shipping), and is only 4.6% lower than the baseline year of 1990. UK car CO₂ emissions are responsible for 68 MtCO₂ which is 61% of the sector’s emissions (Figure 5). Average exhaust emissions of new cars are still increasing despite the increase in sales of electric and hybrid vehicles. This partly due to increased sales of larger and heavier cars.¹³

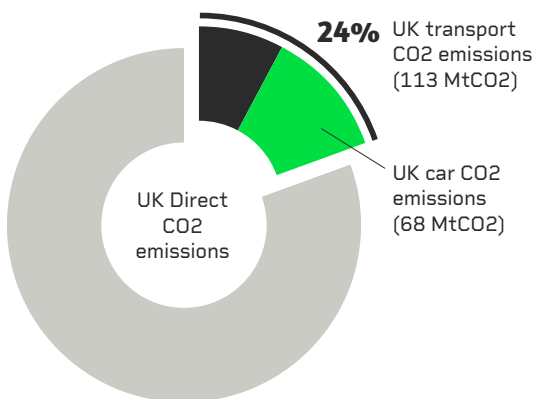

Figure 5: Proportion of CO₂ emissions from UK transport.

E-bikes and other forms of e-micromobility are increasingly being seen as part of the solution in reaching these ambitious emissions targets. According to the UK Energy Research Centre, “cycling is ten times more important than electric cars for reaching net-zero cities”.¹⁴

Micromobility is arguably an important contributor to

transport decarbonisation by encouraging mode shift from private cars, improving air quality, and reducing congestion.

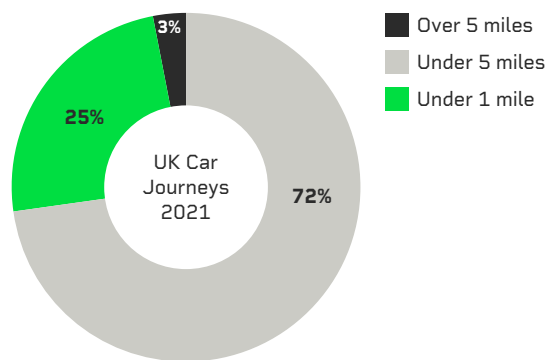

Figure 6: Length of car journeys UK.

In 2021, 72% of journeys in the UK were under five miles and 25% were under one mile (Figure 6). E-bikes and e-scooters have enormous potential to improve sustainable urban transportation systems and could go a long way in helping to reduce emissions.¹⁵

SOURCES

- ⁹ [Institute for Government \(2020\).](#)
- ¹⁰ [Welsh Government \(2021\).](#)
- ¹¹ [Scottish Government \(2019\).](#)
- ¹² [Climate Change Act NI \(2022\).](#)
- ¹³ E-bikes and their capability to reduce car CO₂ emissions Ian Philips *, Jillian Anable, Tim Chatterton.
- ¹⁴ <https://ukerc.ac.uk/news/cycling-is-ten-times-more-important-than-electric-cars-for-reaching-net-zero-cities/>
- ¹⁵ <https://www.gov.uk/government/statistics/national-travel-survey-2021/national-travel-survey-2021-mode-share-journey-lengths-and-public-transport-use>

1.2 SCOPE

Micromobility encompasses a wide range of small lightweight vehicles operating at speeds typically below 25 kilometres per hour and ridden by users personally. Micromobility devices include bicycles, e-bikes, e-scooters, electric skateboards, shared bicycle fleets, and other electric pedal assisted cycles.

This report concentrates mainly on the electrified forms of micromobility (e-micromobility) such as e-bikes, categorised as electrically assisted pedal cycles (EAPC), and e-scooters (Figure 7). It also includes certain powered cycles, such as L-Category vehicles (L1e-A) up to and including 1000 watts, conventional cycles that have been converted to an e-bike by means of a conversion kit, and e-bikes designed for off-road use (up to 1000 watts). Other forms of e-micromobility vehicles, such as unicycles, electric skateboards, and electric hover boards, are not specifically covered by this report.



However, the discussions and recommendations for electric scooters may apply equally to these less common forms of micromobility. Larger forms of electric transport are outside the scope of this report: these include electric vehicles (BEV or EV), plug-in hybrid electric vehicles (PHEV) and L-Category vehicles above L1e-A class such as electric motorcycles, electric mopeds and e-bikes above 1000 watts. However, the threshold between what is classified as an e-bike or electrically pedal assisted bike will be explored in more detail.

Figure 7: Examples of e-bikes and e-scooters in London.



EXAMPLES OF PRODUCTS WITHIN THE SCOPE OF THIS REPORT:

- Electric Pedal Assisted Cycles (EAPC).
- Pedal assisted, Up to 250 watts motor not powered when speed is above 15.5 miles per hour (may have 2, 3 or 4 wheels).
- Powered cycle L category vehicle (PLV class L1e-A).
- Up to 1000 watts motor, not powered when speed is above 15.5 miles per hour (may have 2, 3 or 4 wheels).
- E-bike conversion kits
Standard cycles converted to electric cycle with a lithium-ion battery and motors up to 1000 watts.
- Lithium-ion powered electric scooters (Powered Transporters, PET).

Examples of products outside the scope of this report:

- Products with batteries other than lithium-ion.
- Products other than e-bikes and e-scooters incorporating or powered by lithium-ion batteries.
- Go-Peds – scooters powered by a combustion engine.
- Hoverboards, segways, electric mono wheels (e-unicycles), electric skateboards (PETs other than e-scooters).
- Electric mopeds/motorcycles (PLVs other than L1e-A).
- Electric wheelchairs and mobility scooters.
- Electric vehicles (BEV or EV).
- Plug-in hybrid electric vehicle (PHEV).

Some of the commonly used abbreviations that may be found throughout this report are shown below:

EAPC	Electrically assisted pedal cycle
EPAC	Electrically power assisted cycles
PLV	Powered light vehicle
PLEV	Personal light electric vehicles
PET	Personal e-transporter
EV	Electric vehicle
BEV	Battery electric vehicle
PHEV	Plug-in hybrid electric vehicle



2.0 SAFETY CONCERNS

Along with the growing popularity of e-micromobility products, safety issues relating to their use have come to light. Injuries have occurred, due to impacts, falls and other hazards, such as mechanical, electrical and human factors. According to the Parliamentary Advisory Council for Transport Safety, since 2019 there have been 32 deaths in the UK involving e-scooters, one in 2019, three in 2020, 13 in 2021, 14 in 2022 and one in 2023 (to the end of April),¹⁶ mainly due to falls and collisions on the road.

There is also growing concern over the increasing number of fires caused by lithium-ion batteries that power e-bikes and e-scooters.

Currently, there is limited data relating to the number of fires. The London Fire Brigade (LFB) reported eight fires caused by e-bikes and e-scooters in 2019. This rose to 24 in 2020 and 59 by December 2021. By 2022, the LFB had attended 87 e-bike and 29 e-scooter fires, a total of 116 fires. So far in 2023, on average, the LFB has been called to an e-bike or e-scooter fire once every two days – a 60% increase in the incidence of these fires compared to the same period in the previous year.

The availability of regional data to this level of detail in other areas is patchy, and almost non-existent at national level.

The Incident Recording System (IRS) is a national data collection system, which collects detailed information on all incidents attended by fire and rescue services (FRSs). The IRS enables data on all incidents attended by the UK FRSs to be collected electronically and verified at source. This significantly improves the timeliness and accuracy of data compared to the paper-based 'FDR1' form collection process used in the past. However, the quality of the fire data recorded at national level does not allow fires to be attributed specifically to lithium-ion batteries, e-scooters or e-bikes: the IRS currently has no 'e-scooter' or 'e-bike' category. Firefighters must

Photo (above left) by Alex Yeung© - stock.adobe.com



” So far in 2023, LFB has been called to an e-bike or e-scooter fire once every two days – a 60% increase compared to 2022.

record that a fire involving one of these vehicles in an open text box field. Information entered in an open text box field does not appear in the publicly available fire statistics published by the Home Office.

Such deficiencies in the IRS are hampering developments in fire prevention strategies required to mitigate fires from lithium-ion batteries. These deficiencies need to be addressed as a priority.

Lithium-ion battery fires in London are described by the LFB as currently the fastest emerging and growing fire risk in the capital. The energy expelled in fires involving lithium-ion batteries can lead to particularly intense fires, which present a risk not only to people and property in the vicinity, but also to attending firefighters.

Such is the concern around the fire risk and toxic smoke posed by e-scooters that a number of major transport operators across the UK have banned e-scooters on their trains and in their stations. At the time of this research, a total of 16 operators have bans in place that, in many cases, extend to similar machines including e-hoverboards, e-unicycles and e-skateboards.

SOURCE

¹⁶ <https://www.pacts.org.uk/the-safety-of-private-e-scooters-in-the-uk-pacts-research/>



Tragically, in the first three months of 2023, lithium-ion battery fires in the UK had already taken four lives, left others hospitalised or seriously injured and caused extensive damage to property. Sofia Duarte sadly died on New Year's Day in a flat in South Bermondsey, London, from a fire that was believed to be started from a converted e-bike's battery bursting into flames in the entrance to the flat where Sofia lived. A few days later, in Liverpool, a 60-year-old man died at home in a blaze caused by an e-bike charging overnight. Merseyside Fire and Rescue Service said a second man, his son in his 20s, had now also died as a result of injuries sustained in the fire. In March 2023, father-of-two Mizanur Rahman, 41, died after a fire in a three-roomed flat in Tower Hamlets, east London, involving an e-bike.

When it comes to the devastating consequences of lithium-ion battery fires from e-bikes and e-scooters, the UK is not alone. In New York City, there have already been a total of 59 e-bike-related fires from January to the beginning of April 2023. During this period, fire officials reported five fatalities from these fires – compared to six deaths in the whole of 2022. Most recently, a bike's battery caught fire while being charged near the front door of an apartment building. The blaze spread to the rest of the block, taking the lives of two young people.

Media reports of fire-related incidents

Analysis from Electrical Safety First's media monitoring systems between April 2022 and March 2023 reveals an alarming rise in the number of reported e-scooter and e-bike fires (Figure 8). This analysis has identified some of the key factors which may have influenced

the overall trends in fire-related incidents.

A total of 37 property fires were reported over the

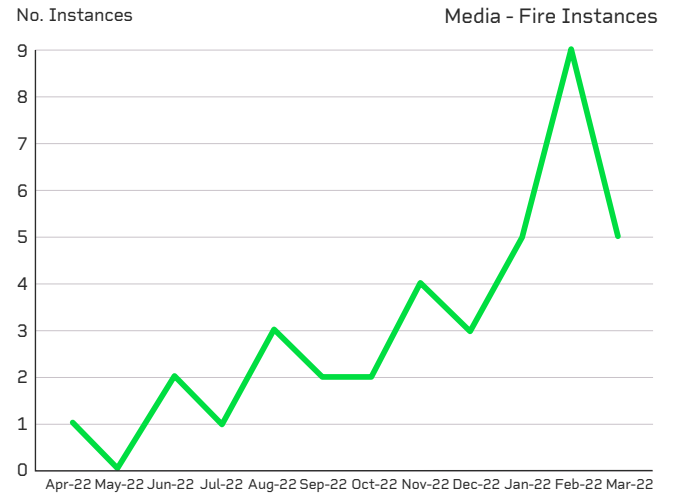

Figure 8: The number of property fires caused by e-bikes and e-scooters reported monthly over a 12-month period.

12-month period, of which 51% occurred at night. 81% were associated with e-bikes and 16% were attributed to e-scooters. In most cases, there is very limited information given that could identify the exact cause of the fire, although 16% of the reports did record the involvement of an e-bike conversion and 19% indicated that the e-bike or e-scooter was being charged when the fire occurred.

81% of the fires occurred in domestic accommodation, 47% of which were houses, 53% of which were flats and 19% of which were reported as houses of multiple occupancy. The reporting of the fires by the media was not always detailed. However, 43% of fires in domestic accommodation were reported as starting in bedrooms, kitchens, hallways and front rooms.

These reports indicate that there is a serious safety risk with e-bikes being stored or charged in certain residential locations, such as fire exit routes. As half of the fires occurred overnight, the risk to life and catastrophic property damage significantly increases when the e-bike or e-scooter has been left charging and unattended, as the reaction time is greatly reduced when a resident is asleep.

The media reports used for this analysis are listed in:

ANNEX A

Fires from lithium-ion batteries

One of the primary risks related to lithium-ion batteries is thermal runaway. Thermal runaway is a major challenge in the lithium-ion battery field due to its uncontrollable and irreversible nature, which can lead to venting of toxic fumes, fires and explosions.

Faults in a lithium-ion cell can result in thermal runaway. These faults can be caused by internal failure or external conditions and can lead to battery temperatures far beyond the manufacturer ratings. An internal failure can occur in cells of poor-quality design and/or manufacture that cause short-circuits.

Three main external conditions can contribute to battery failure:

- **ELECTRICAL:** typically overcharge or over-discharge – can be due to incompatibility between battery and charger, or a faulty/sub-standard battery management system (BMS). External short-circuit. Ingress of water causing short-circuit or protection circuitry failure.
- **MECHANICAL:** triggered by crushing or penetration of a battery with an external object. Can also be caused by extreme or repeated impact, such as striking a kerbstone.
- **THERMAL:** extreme high and low temperature environments.

Thermal runaway is initiated by a failure event that causes the temperature to increase to the point where a lithium-ion cell enters an uncontrollable, self-heating

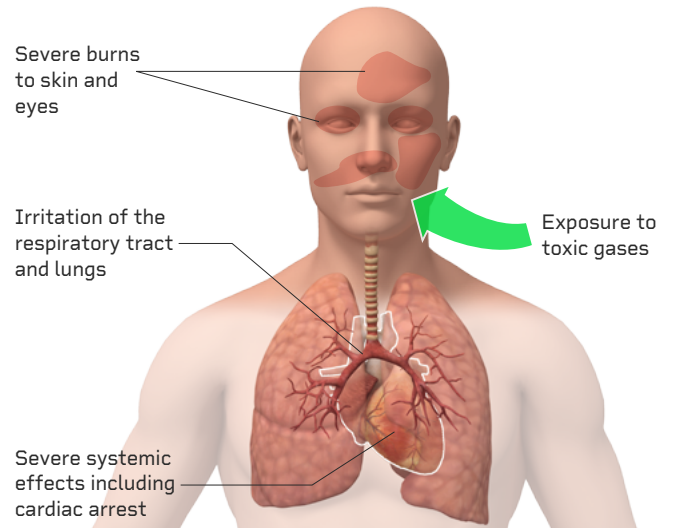

Figure 10: Human exposure to the toxic gases.

state. Exothermic reactions (generating heat) within the cell lead to a further temperature increase and a build-up of pressure due to the generation of various gases. As exothermic reactions continue, the internal structure of the cell begins to become unstable, break down and collapse, resulting in the venting of a vapour cloud of highly flammable and toxic gases, fire and explosion. Thermal runaway within a cell rapidly heats other adjacent cells within a battery pack, causing them also to enter a state of thermal runaway – a process known as thermal propagation. Even if the lithium-ion battery fire is extinguished, it is common for the fire to start again, highlighting the dynamic nature of lithium-ion battery fires (Figure 9).

In addition to the fire and explosion risks, vented gasses are highly toxic. They include hydrofluoric acid (HF), which can cause severe systemic effects (including cardiac arrest) and severe burns to the skin, eyes or digestive tract. If inhaled, HF can also cause irritation of the respiratory tract, including pulmonary oedema (Figure 10).

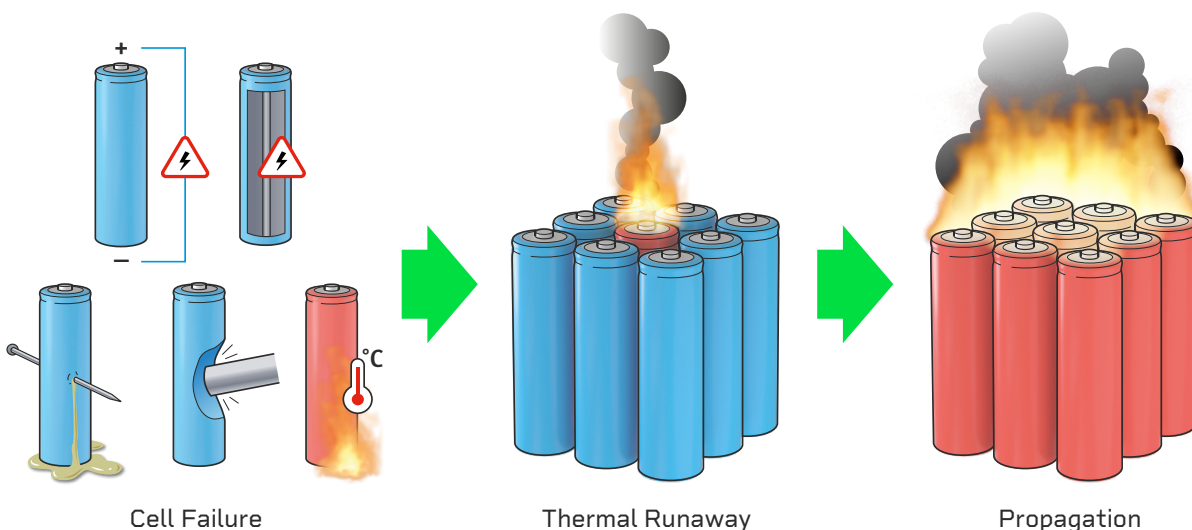

Figure 9: Stages of thermal runaway.



Figure 11: ©ESF Onset of thermal runaway – venting of a vapour cloud of highly flammable and toxic gases.

Scientific studies suggest that events leading to the onset of thermal runaway can commence at a temperature as low as 60°C, and then escalate exponentially within seconds to temperatures in excess of 600°C – temperatures beyond the melting point of battery casing materials, such as plastics and metal alloys – allowing flames and cell content to be ejected to surroundings.



RECOMMENDATIONS

- Government, fire and rescue services and consumer protection organisations should run consumer awareness campaigns about the risks associated with e-bikes and e-scooters being stored or charged in certain residential locations, such as fire exit routes.
- The Home Office should expand the current Incident Recording System to become a robust, up-to-date national fire data collection system that enables fires to be specifically attributed to e-micromobility batteries.

CONVERSION KITS AND MODIFICATIONS

Giving your ride a boost or the road to prosecution

In 2022, Freedom of Information data obtained by Zurich Insurance UK revealed that e-bikes and e-scooters were responsible for 167 fires in the UK in 2021; a significant increase on 67 fires in 2020.¹⁷ There were 161 incidents recorded to the end of September 2022, a 28% increase on the 2021 monthly average. These figures represent a surge in fires from these products of almost 150%, triggering a stark warning from the Chartered Trading Standards Institute (CTSI) about the risks posed by non-compliant e-scooter and e-bike lithium-ion batteries.¹⁸

In London alone, firefighters tended to **88 fires** caused by e-bikes in 2022, representing an **80% increase** from **49** in 2021.

With statistics like these, it can be easy to see why there have been numerous warnings issued by fire and rescue services around the country.¹⁹

Many of the fires reported have been linked to conversion kits, which convert a manual pedal cycle into an e-bike (Figure 12). The London Fire Brigade (LFB) has issued warnings about the prevalence of fires from e-bikes that have been converted, predominantly from conversion kits and batteries purchased from online marketplaces, which may not meet the correct safety standards. Additionally, the LFB has reported that many of the fires attended are attributed to e-bikes stored in communal areas and corridors that



Figure 12: A typical conversion kit.

can block the only means of escape if a fire breaks out.

As conversion kits sold online can be a fraction of the cost of a ready-built e-bike, they are more likely to appeal to those with less disposable income. Furthermore, concerns have been raised around a growing cottage industry seeking to cash in on bike conversions, adapting ordinary pedal cycles that are then supplied to consumers. These businesses may not be aware that anyone in the supply chain can be held liable for the supply of unsafe products.

SOURCES

¹⁷ <https://www.zurich.co.uk/news-and-insight/fires-sparked-by-e-bikes-and-e-scooters-surge>

¹⁸ tradingstandards.uk/news-policy/news-room/2023/ctsi-issues-warning-about-e-bike-and-e-scooter-battery-fires/

¹⁹ bbc.co.uk/news/uk-england-bristol-63031602



Notwithstanding the rise in incidents and the warnings being issued, correctly designed and fitted conversion kits sourced from reputable manufacturers and retailers, fitted professionally to a suitable cycle, are not inherently dangerous.

DIY conversions should be discouraged. We should therefore, question the judgement of some delivery businesses that offer guidance on converting your own bike:

” <https://riders.deliveroo.co.uk/en/news/converting-an-ebike>

The dangers and the reported incidents tend to result from a number of risky practices, such as modifications to electrical systems, and from the sale of conversion kits that are not adequately regulated in the same way as ready-built e-bikes or e-scooters. For example, a dedicated safety standard exists for e-bikes that can help manufacturers demonstrate that their products meet legal safety requirements. Similar safety standards exist for ready-built e-scooters and other types of e-micromobility.

When it comes to conversion kits, there is no dedicated standard. The product being sold is not a finished product, and in many cases, does not include all of the components required to build a complete e-bike. Many conversion kits available online do not include the battery, an essential component of any e-bike. The selection of a suitable battery and charger is left to the consumer to source and ensure compatibility. When a consumer converts a standard bicycle to an e-bike, in the eyes of the law, they take on the role of a manufacturer (perhaps unknowingly), and in doing so, **take full responsibility for safety and conformity to applicable legislation.**

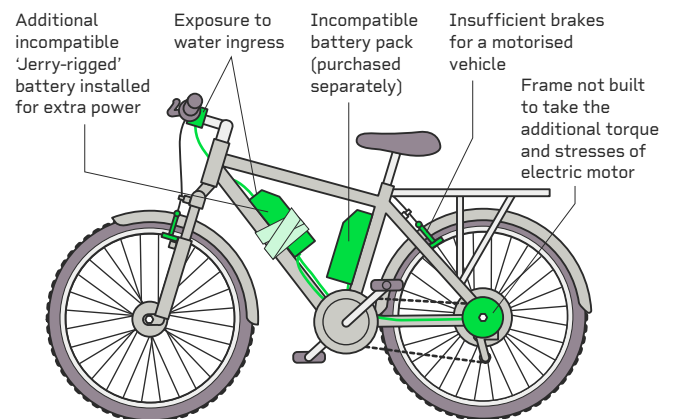

Figure 13: Associated risks of a DIY e-bike conversion.

There are also risks associated with modifying a standard bicycle that may not take into account the manufacturer’s original design and intended use. Standard bicycles often have a frame and braking system that was never designed or intended to take the extra weight of conversion kit components, or handle the torque and stresses of the electric motor, even with a conversion kit that is designed to modify the bike within the legal framework of an EAPC classification of a ‘normal pedal bike’ (Figure 13).²⁰

Many conversion kits that are available from less scrupulous dealers are more powerful. They push a DIY-built e-bike beyond the legal safeguards of EAPC rules and leave the user and pedestrians vulnerable to serious injury, and the former, liable to prosecution.

SOURCE

²⁰ <https://www.gov.uk/electric-bike-rules>

The need for more speed and the legal implications

A road-legal EAPC e-bike will be pedal-assisted and have a motor with maximum power output of 250 watts, which will not propel the bike when it is travelling more than 15.5 miles per hour. There are many examples of conversion kits supplied with motors that are rated at four times the acceptable power limit for EAPCs, enabling the rider to exceed the maximum travelling speed. These kits include a throttle, and are sold under the guise of ‘**FOR OFF ROAD USE**’. Fitting one of these kits to a pedal bike that does not meet EAPC rules fundamentally re-classifies the bicycle as a motor vehicle under the Road Traffic Act 1988 (similar to a motorcycle or moped), requiring it to be type approved, registered, taxed and insured. Consequently, it is unlikely that this type of conversion kit e-bike could meet the specified performance requirements for motor vehicle type approval, in which case motor insurance will be unobtainable. The rider is therefore left at risk of prosecution for offences under the Road Traffic Act 1988.

The need to go further and to carry more

The range of any e-bike, whether it is ready-built or a conversion of a normal pedal bike, depends on a number of factors, including weight, terrain, wind speed, rider input and battery capacity. Typically, riders can expect a range of around 20-50 miles from their e-bike, taking into account component and design specifications. For most riders who use their e-bikes for the daily commute or for leisure pursuits, this range may be adequate. However, there is a group of riders for whom this range may not be enough.

There are a growing number of delivery drivers in London, from one-man self-employed fast food delivery riders, to large scale commercial parcel delivery operations. Last mile e-bike delivery solutions are becoming widespread and can be seen everywhere in London and other city centres (Figure 14). Amazon reported that it had made more than five million deliveries in 2022 using its e-cargo bikes and electric van fleet within London’s Ultra Low Emission Zone, as part of a five-year



Figure 14: E-cargo bikes delivering in London.

£300 million investment in the electrification and decarbonisation of the company’s UK transportation network.²¹ For these professional riders, the battery range of a standard e-bike is unlikely to suffice. For large commercial operations, the logistics can be planned, with strategically located central hubs and charging facilities that enable commercial e-cargo bikes of large companies, such as Amazon, DHL and UPS, to deliver parcels all day long.

SOURCE

²¹ <https://www.aboutamazon.co.uk/news/sustainability/amazon-expands-electric-cargo-bike-deliveries-in-manchester-and-london>



Figure 15: An example of a modified e-bike in London.

However, these facilities are not generally available to self-employed delivery riders, leaving them to come up with their own alternative solutions. This can result in risky DIY modifications, such as fitting additional battery packs to a standard e-bike (Figure 15 and 16).

Many of these modifications may involve increasing the power of the e-bike or adding a throttle, but that is not always the case. The practice of fitting additional battery packs in order to increase the range of the e-bike does not in itself make an e-bike illegal in the same way as increasing its power does. These types of modifications do however increase the risks of both injury and fire. Overloading the mechanical parts of the e-bike with multiple batteries will increase the wear on the gear systems, brakes, and tyres, as well as making the bike less stable and increasing the stopping distance in the event of an emergency. Modifications to the electrical systems increase the risks of incompatibilities during charging and discharging.

SOURCE

²² <https://www.london-fire.gov.uk/safety/lithium-batteries/charging-electric-bike-and-electric-scooter-lithium-batteries/>

Interconnected batteries and their respective states of charge cannot be managed or monitored adequately to ensure safety. Damage to batteries in the event of a road traffic incident is highly likely due to the makeshift way that many of these multi-battery systems are mounted on the bikes.

In an attempt to reduce the number of e-bike fires, the London Fire Brigade has recently launched its [Charge Safe Campaign](#)²² which gives advice on the dangers relating to charging, storing and modifying e-bikes and e-scooters and their batteries. In support of their efforts to promote the campaign, the brigade has engaged with many of the major delivery companies, such as Just Eat, Deliveroo and Uber Eats, to share the key safety messages with their riders.

Compliant lithium-ion battery packs are fitted with a battery management system (BMS). The BMS monitors and controls the cells, regulates the state of charge, voltage and current of each cell, and additionally may monitor the temperature of the cells in the battery pack. As well as protecting the cells from overcharging, the BMS also protects against over discharge, switching off the load when the battery voltage reaches a certain level, typically between two and three volts per cell. If a lithium-ion battery is discharged too deeply, it can cause damage to the cells. It may then not be able to hold a charge, or it



Figure 16: Examples of modified e-bikes in London.

could experience reduced life or performance. In some cases, an over-discharged lithium-ion battery may even catch fire. Despite these dangers, there are numerous videos online describing how to modify or bypass the battery BMS in order to increase the extent of charge/discharge, at the expense of the safety systems put in place by the manufacturer (Figure 17).

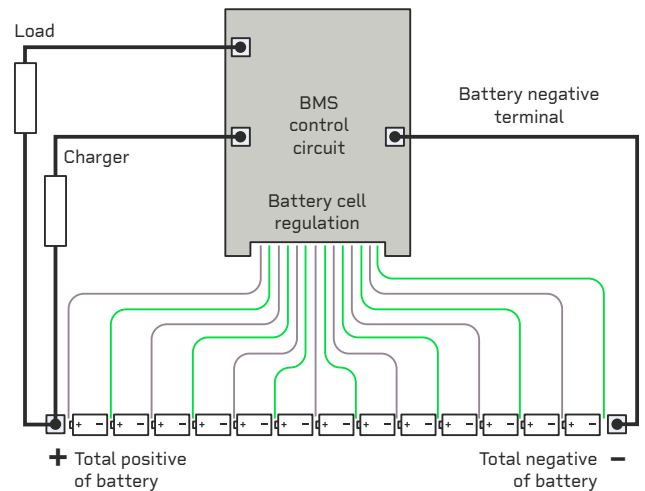

Figure 17: Diagram of a Battery Management System.

RECOMMENDATIONS

- Further consumer education is needed about the risks and liabilities of modifying a pedal bike to an e-bike using a conversion kit.
- Government must raise awareness of the legal implications of converting or purchasing an e-bike beyond the EAPC rules.
- Delivery service businesses should take responsibility and liability for the safety of their riders who use e-micromobility vehicles. They should also consider providing their riders with e-bikes, or an incentive scheme to encourage riders to use e-bikes provided by the company.
- Delivery service riders who use e-micromobility vehicles must declare that their mode of transport is road legal.
- Delivery service businesses should stipulate e-micromobility specifications and maintenance requirements.
- Delivery service businesses should consider providing a safe charge bag or similar fire-protection enclosure to riders who use e-micromobility vehicles.
- UK Government should mandate the development of a product standard, specific to conversion kits and associated components.
- UK Government should introduce legislation to ensure that online marketplaces take reasonable steps to prevent or delist unbranded and potentially non-compliant conversion kits.

2.2 DANGEROUS COMPATIBILITY OF CHARGERS AND BATTERY VOLTAGES



Figure 18: E-bike battery following a thermal runaway event caused by overcharging.

” Using an incompatible charger can result in serious damage to the battery and potentially cause a fire or explosion.

E-bike and e-scooter chargers are designed to recharge the battery of an e-bike or e-scooter at a specific output voltage and current. It is crucial to ensure that the charger and the battery are compatible; using an incompatible charger can result in serious damage to the battery and potentially cause a fire or explosion (Figure 18).

The voltage (V) of an e-bike or e-scooter battery varies depending on the type and model of the e-bike or e-scooter. Typically, batteries have a voltage range between 24V and 72V, with some higher-end models having voltages up to 100V. The charger must provide the correct voltage to the battery to ensure that it is

charged properly and does not overcharge.

Using a charger with a voltage that is too high for the battery can lead to overcharging, which can cause the battery to heat up and even explode. Conversely, using a charger with a voltage that is too low can result in undercharging, which can reduce the battery's lifespan and performance.

The situation is further complicated by the fact that the correct charging voltage for a particular battery is not the same as the battery voltage. The relationship between battery voltage, the ideal charging voltage and the rate of charge is different for different battery chemistries. For example: a nickel manganese cobalt (NMC) lithium-ion battery requires a charger that is 4.2V per cell (10 cells in series = 36V; Charger = 42V). In contrast, a lithium iron phosphate (LiFePO₄) battery requires a charger that is 3.65V per cell (10 cells in series = 32V; Charger = 36.5V).

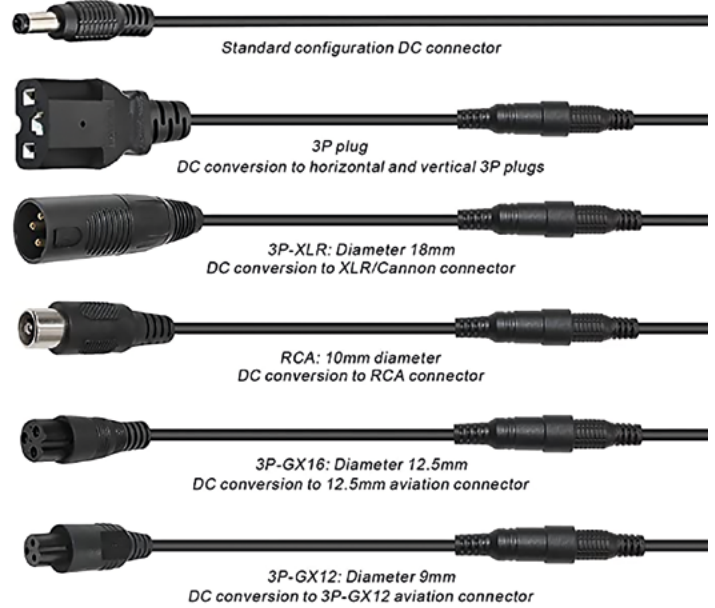
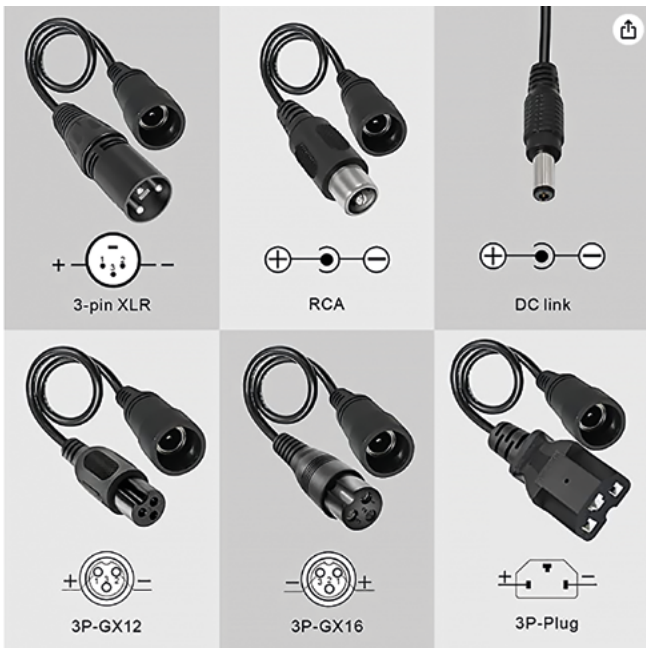

Figure 19: Examples of connectors supplied with a universal charger.

Connector types

The problem of dangerous compatibility of chargers and battery voltages is also compounded by the availability of universal chargers supplied with connectors that will fit most batteries (Figure 19).

During our investigations, we found examples of battery chargers with output voltages of up to 96.6V supplied with six different types of common connector compatible with the majority of batteries with voltages ranging from 12V to 96V. Many of the universal connector types being used for charging were originally designed for extra-low voltage systems, such as the ‘XLR connector’, typically used with professional audio and video systems, which may not be suitable for the voltages they are being used with.

There are currently no voltage limits for battery and charging systems on e-bikes and e-scooters, and voltages greater than 60V DC may also introduce additional electric shock risks that are not dealt with by the majority of e-bike and e-scooter standards.

A couple of possible technical solutions could be adopted to solve the issues of dangerous compatibility of chargers and connectors, depending on whether a proprietary or non-proprietary system is selected. Both solutions are outlined in detail in the Technical Specification ISO/TS 4210-10: 2020. Cycles. Safety requirements for bicycles Part 10: Safety requirements for electrically power assisted cycles (EPACs).²³

For the proprietary system, measures are put in place to ensure that the battery can only be charged with the dedicated charger supplied with the e-bike. By using bespoke connector systems or modified connector systems that are not interchangeable with standard connectors, manufacturers can reduce the risk of the battery being charged with an incompatible charger.

For the non-proprietary system, different types of chargers can be connected to the battery. Therefore, in the non-proprietary system, measures have to be put in place to protect the battery from overvoltage, overcurrent, overtemperature, short circuit and inadvertent disconnection. It is important that the control systems are on the battery side (aboard the e-bike or e-scooter), so that the battery and associated circuits can establish communication with the charger and control the charging currents and charging voltages at all times – similar to the communication and protocols used when charging your mobile phone.

SOURCE

²³ <https://www.iso.org/standard/80890.html>

77 The compatibility of charger and battery is critical to ensure the safe and efficient charging of e-bikes and e-scooters. It is essential to use only the charger that is provided, or a manufacturer's approved charger that is designed specifically for the battery voltage range.

The compatibility of charger and battery is critical to ensure the safe and efficient charging of e-bikes and e-scooters. It is essential to use only the charger that is provided, or a manufacturer's approved charger that is designed specifically for the battery voltage range. Using a third-party charger that is not compatible with the battery can lead to dangerous consequences. Limiting the voltage of the battery and charging system to within the Safety Extra-Low Voltage (SELV) range, i.e. max 60V DC, would also reduce the additional risk of electric shock.



RECOMMENDATIONS

- Government, fire and rescue services and consumer protection organisations should launch a consumer education campaign that reinforces the safety messages around safe charging practices.
- Government should consider prohibiting the sale of universal chargers for e-micromobility vehicles or introduce standards for non-proprietary charging systems.
- The Office for Product Safety and Standards (OPSS) should adopt the technical specification ISO/TS 4210-10: 2020. Cycles. Safety requirements for bicycles Part 10: Safety requirements for electrically power assisted cycles (EPACs) as a designated standard to mitigate risks of dangerous compatibility/charging.
- UK standardisation bodies should consider the marking requirements for the e-micromobility standards, such that the battery or charging port shall be marked with the voltage required for charging.
- The Department for Transport should consider introducing within the EAPC general requirements a 60V DC limit on all electrical circuits including the charger to protect against electric shock. The same limitation should also apply to any future requirements that legalise the use of private e-scooters on roads. This aligns with the voltage limit specified in the Technical Specification – Safety requirements for electrically power assisted cycles [EPACs] ISO/TS 4210-10:2020.

2.3 FATALLY FLAWED DESIGN

E-scooters

E-scooters have often been cited as the eco-friendly solution to congestion in our towns and cities. Governments and policy makers around the globe are exploring e-scooters as a solution to ease congestion for the beginning and end of a journey taken on public transport, often referred to as the ‘last mile’ or ‘first and last mile’. E-scooters are easy to ride, do not emit harmful pollution when in use, are quiet, and take up a lot less space on the road than a car.

Seeing the huge increase in the presence of powered scooters in our towns and cities over the past few years may lead you to believe that they are a new invention; in reality, the design has been around for over 100 years (Figure20).²⁴ The initial idea was to create a vehicle that was smaller and lighter than the load it was designed to carry. However, as with most compromises, these solutions bring with them their own disadvantages.

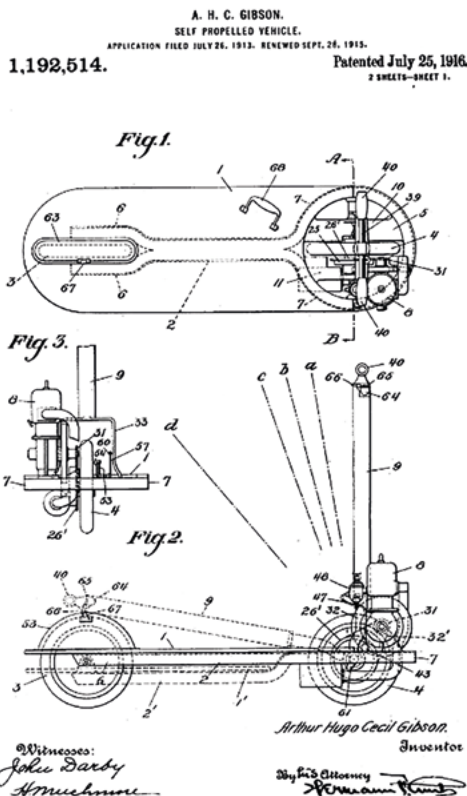

Figure 20: United States Patent for a self propelled vehicle US1192514A.

” Many e-scooters have the battery compartment mounted underneath the deck. These are very close to the ground and susceptible to mechanical damage. They are also at greater risk of water damage, unless adequately protected against water ingress.

The majority of e-scooters have small wheels, usually around 150-200mm in diameter. That’s not the ideal design for navigating changes in road surface and obstacles. Compared to a bike with a 26” wheel, the additional force required to get over a 50mm kerb can be as much as 100%²⁵ and close to infinity when the obstacle approaches the radius of the wheel. Using this relationship, it is easy to imagine the most likely outcome when an e-scooter wheel hits a pothole that is just 3” (75mm) deep.

Other inherent design aspects of scooters can adversely affect control and stability.²⁶

Most e-scooters are designed with the deck mounted just above the axis of the wheels. Many have the battery compartment mounted underneath the deck. These deck-mounted batteries are very close to the ground and, as such, are susceptible to mechanical damage when navigating obstacles. They are also at greater risk of water damage, unless they are adequately protected against water ingress. Such protection can, however, reduce ventilation, which is required by the battery to keep cool, increasing the risk of overheating unless temperature rise is controlled.

SOURCES

²⁴ <https://patents.google.com/patent/US1192514A/en>

²⁵ <https://journals.sagepub.com/doi/full/10.1177/1729881416687135>

²⁶ <https://swiftyscooters.com/blogs/journal/e-scooter-safety-and-design>

E-scooter and e-bike design improvements

E-bikes

The basic bicycle frame design has remained essentially unchanged for over a hundred years and most current e-bikes have adopted this well proven design. The main design considerations in relation to an e-bike can therefore be centred around electrical safety.

The battery requires impact protection, and the bike frame can be utilised to minimise risk of damage from impact. Therefore, mounting the battery centrally on the frame, in conjunction with a properly designed enclosure, or integrating the battery into the frame can be considered as a means of achieving protection against mechanical impact (Figure 21).

Another consideration for electrical safety is protection against water ingress. Bikes are used in all kinds of weather and often stored outside. This is not generally a concern for a standard pedal bike, where leaving the bike exposed to the elements might result in superficial corrosion or, in the worst cases, seized mechanical components. For an e-bike the risks are much higher. Water can damage the bike's electrical components, such as the motor, controller or battery. Water ingress can result in short circuits in the electrical system, which can cause components to fail or even lead to a fire.

In the UK, water resistance ratings are specified as IP ratings (Ingress Protection). Product standards specifically applicable to different types of e-mobility typically require the electrical systems to be protected to either IPX4 (EAPCs and e-scooters) or IPX5 (off-road e-bikes), which translates to 'protected against water splashes' and 'protection against water jets' respectively. In some safety standards generally applicable to e-mobility, additional water immersion tests are required to simulate foreseeable operating conditions, such as flooding. This highlights some inconsistencies in expected safety levels and the standardisation process, which needs to be addressed.

For an e-bike the risks are much higher. Water can damage the bike's electrical components, such as the motor, controller or battery. Water ingress can result in short circuits in the electrical system, which can cause components to fail or even lead to a fire.

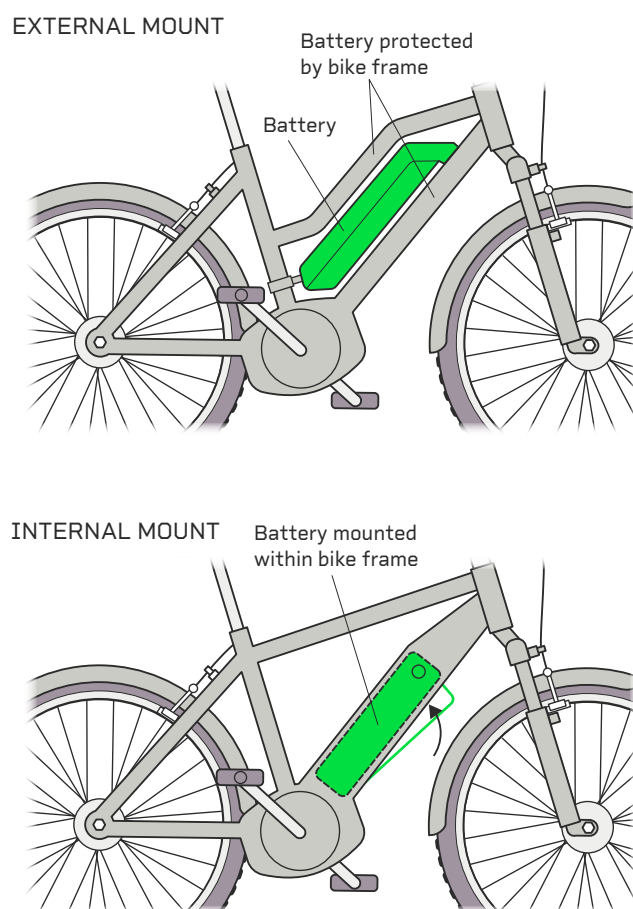

Figure 21: Recommended e-bike battery locations.

E-scooters

If e-scooters are to become one of the solutions to decarbonising our journeys, a number of unacceptable safety issues need to be addressed.

Lithium-ion batteries require protection from impact and water ingress. The combination of the small wheels and low-mounted deck batteries is likely to result in battery damage, which can result in fire. Mounting the battery higher, such as on the handlebar stem, would make the battery less

susceptible to water ingress from puddles and impact from mounting kerbs, riding across drains and hitting potholes. However, when mounting the battery in a raised position, the position of the battery enclosure to maximise impact protection and the stability of the e-scooter as a whole still need to be considered carefully.

Kerbs are one of the more obvious potential hazards to e-scooter riders. Kerbs vary in height depending on their purpose, although the Highways (Road Humps) Regulations 1999 indicate that a standard kerb height is to be regarded as between 125 to 150mm. Numerous other references online also quote the same dimensions for a standard kerb.

The Parliamentary Advisory Council for Transport Safety (PACTS) and the European Transport Safety Council (ETSC) recommend a minimum front wheel size of 30.5cm (12") and minimum rear wheel size of 25.5cm (10").²⁷ A larger wheel size,

in conjunction with other design improvements, helps increase the stability of the e-scooter, but may not reduce the probability of impact to a deck-mounted battery. In this case, a minimum deck-to-ground clearance should be specified.

Hitting a deep pothole or mounting a kerb (for example to avoid a collision) are likely to present a significant risk of battery impact. As the Highways (Road Humps) Regulations 1999 regard a standard kerb height within the region of 125 to 150mm, it would be reasonable to propose a minimum ground clearance of 150mm. Furthermore, a minimum IP rating of IPX5 (as specified for electric mountain bikes) would be recommended to protect against water ingress. The addition of a seat would also help with lowering the centre of gravity, aiding the position of the rider in relation to the steering, and provide additional options for mounting the battery (Figure 22 and 23).

Recommended E-scooter Design

Optional inclusion of a seat will lower devices centre of gravity and increase stability

Minimum recommended road to deck clearance of 150 mm to minimise impact damage

Battery moved away from deck and housed within stem of main frame to reduce risk of mechanical damage

Battery and electrical systems should be IPX5 compliant to protect against water ingress

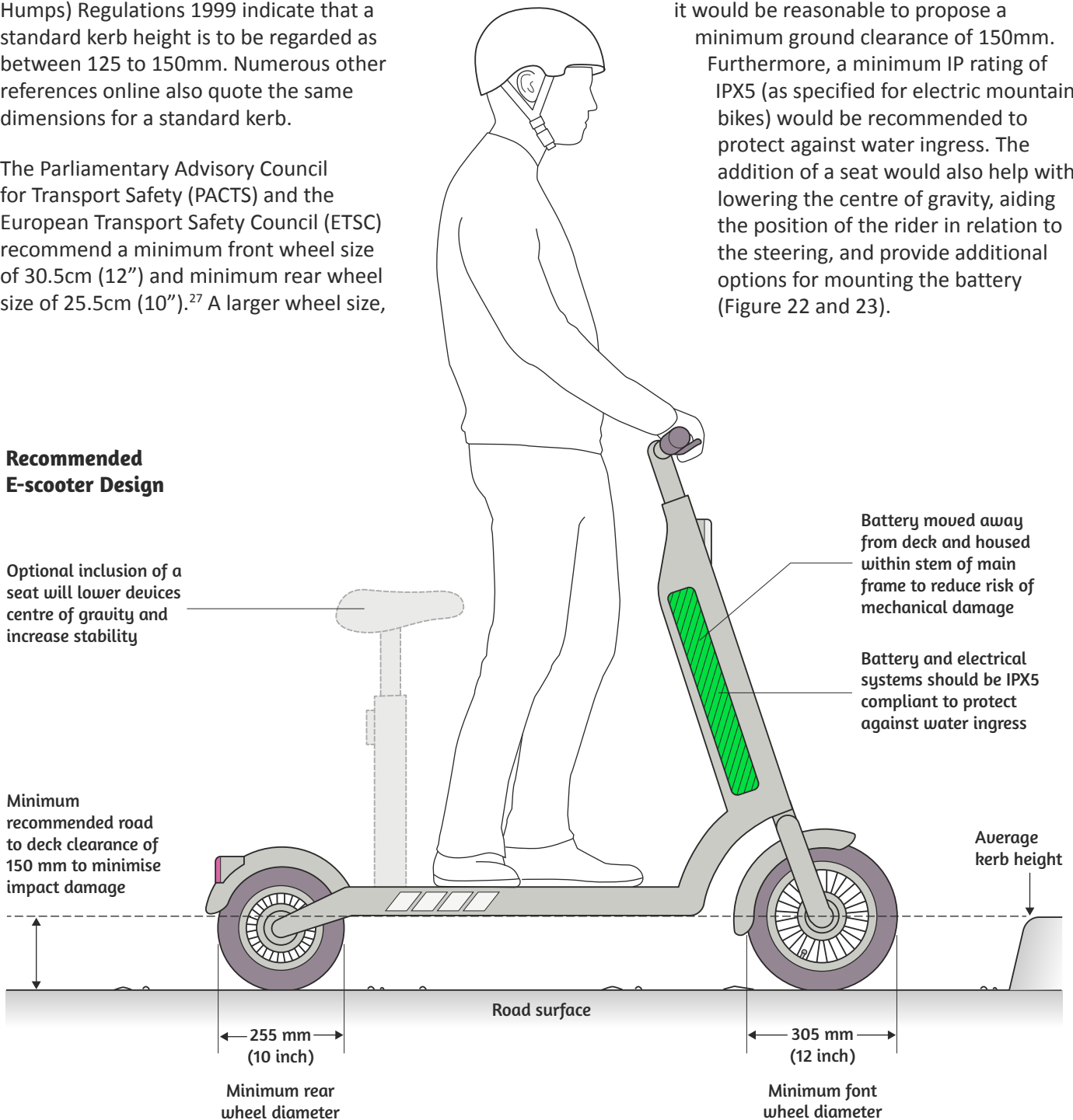

Figure 22: Recommended e-scooter design.

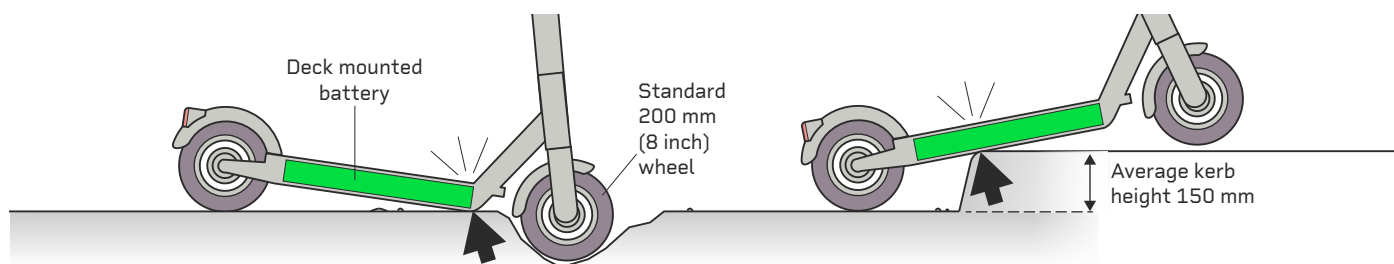

Figure 23: Collision risks to e-scooter battery.

77 Hitting a deep pothole or mounting a kerb (for example to avoid a collision) are likely to present a significant risk of battery impact.

Charging considerations

Many fire and rescue services and fire investigators have reported a rise in battery fires, particularly during the charging cycle, and have issued advice on safe charging and storage practices. For example, the National Fire Chiefs Council advises: “Always use the manufacturer approved charger for the product, and if you spot any signs of wear and tear or damage, buy an official replacement charger for your product from a reputable seller”.²⁸

Some fire and rescue services recommend charging and storage outdoors to mitigate collateral damage in the event of a fire. However, the majority of chargers (even from recognised brands) are designed for indoor use only. Manufacturers should consider making available alternative proprietary charging systems suitable for outdoor use, in support of this recommendation.

The fire safety risk is heightened by the availability of unbranded, substandard and incompatible chargers that continue to flood the market. Tighter regulation and targeted enforcement is needed to meet consumer safety expectations.

SOURCES

²⁷ <https://www.pacts.org.uk/pacts-and-etsc-set-out-safety-recommendations-for-e-scooters-and-their-riders/>

²⁸ <https://www.nationalfirechiefs.org.uk/E-bikes-and-e-scooters-fire-safety-guidance>

RECOMMENDATIONS

- Government, fire and rescue services and consumer protection organisations should launch a consumer education campaign that reinforces the safety messages about safe charging practices.
- The Department for Transport should consider implementing the safety-in-design features recommended in this report as the industry standard, alongside the recommendations on safety of e-scooters from the European Transport Safety Council (ETSC) and the UK Parliamentary Advisory Council for Transport Safety (PACTS) [here](#).
- The requirements specified in product standards for e-micromobility need to be better aligned. The Office for Product Safety and Standards should mandate a review of the product safety standards referenced in this report for inconsistencies and conflicting specifications that could otherwise lead to legal uncertainty.
- The Office for Product Safety and Standards should review the various manufacturing and consumer markets supplying dangerously compatible charging products. They should also consider introducing tighter controls and prioritise enforcement to prevent these products being available on the UK market.

2.4 DISPOSAL OF LITHIUM-ION BATTERIES



” **Lithium-ion batteries cause 201 waste fires every year (around 48% of all waste fires occurring in the UK each year), costing around £158 million annually.²⁹**

When discarded, lithium-ion batteries and battery-operated devices should be disposed of at household waste recycling centres, e-waste collection points or battery-recycling drop-off locations.

However, research published by private waste sector trade body the Environmental Services Association (ESA) and consultancy Eunomia in 2021 suggested that lithium-ion batteries cause 201 waste fires every year (around 48% of all waste fires occurring in the UK each year), costing around £158 million annually.²⁹

In December 2022, Material Focus, the not-for-profit organisation funded by the Waste Electrical and Electronic Equipment (WEEE) compliance fee, published the results of a survey of local authorities on fires. The results suggest that batteries which have not been removed from unwanted electricals cause more than 700 fires annually in refuse collection vehicles (RCVs) and at household waste recycling centres (HWRCs), while nearly 90% of the 60 local authorities surveyed said fires caused by batteries are “an increasing problem”.

The research also found that up to 45% of householders are unaware of the fire risk if they do not safely dispose of batteries, while 40% are unaware of any information regarding how they should recycle their batteries.

Marking and disposal instructions requirements for lithium-ion batteries are covered by the Batteries and Accumulators (Placing on the Market) Regulations and applicable standards.

Batteries should be labelled with the crossed-out wheeled bin to indicate that they shouldn't be disposed of as normal waste (Figure 24), along with storage and disposal instructions that, if they cannot be marked on the battery, must be supplied with the battery.

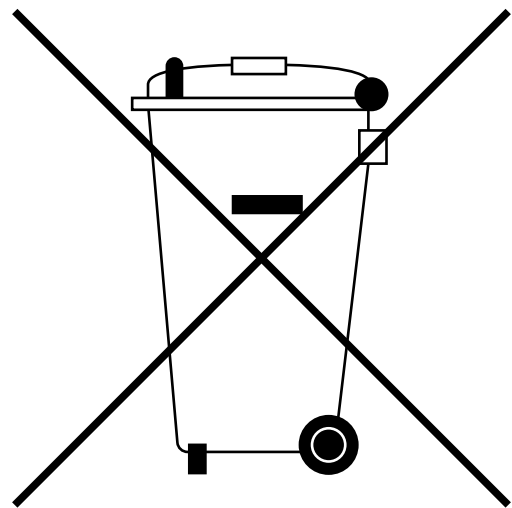

Figure 24: 'Do not dispose in normal waste' symbol.
<https://www.gov.uk/guidance/batteries>

SOURCE

²⁹ <https://www.eunomia.co.uk/lithium-ion-battery-waste-fires-costing-the-uk-over-100m-a-year/>



Figure 25: Lithium-ion test purchases labelling.

The Office of Product Safety and Standards (OPSS) enforces a range of regulations aimed at addressing the environmental challenges associated with the disposal of electrical and electronic equipment and batteries. In 2021/22, OPSS conducted a **Battery Takeback Online Project**, which was developed to ensure that online retailers were aware of their battery takeback obligations and were compliant with those obligations. OPSS identified 82 online retailers who were not providing the correct information to their consumers on battery takeback. Furthermore, 1,500 non-compliant lithium-ion cells were removed from the market following an investigation into mislabelling of batteries.³⁰

The lithium-ion battery test purchases listed in section 5 of this report were marked with the 'crossed out wheelie bin' symbol. However, no further instruction, markings or guidance on safe disposal was provided with any of the purchases (Figure 25).



A report entitled 'Cutting Lithium-ion Battery Fires in the Waste Industry', produced by Eunomia and the ESA, concludes that there are barriers to consumers correctly disposing of lithium-ion batteries and electrical products containing batteries. Most battery collection points are located in HWRCs out of town requiring transport, and retail take-back collection points generally will only accommodate very small batteries, such as AA and AAA batteries. Consequently, many waste electrical items containing batteries end up being disposed of in general or mixed recycling bins.³¹

” Solutions include banning lithium-ion batteries from the residual and mixed recycling waste streams, introducing a deposit return scheme (DRS) for batteries, and making battery manufacturers pay for the costs of dealing with the fires their products cause.



In 2020, the ESA launched a campaign called 'Take Charge' (<https://www.takecharge.org.uk/>) in an effort to persuade the public to recycle batteries responsibly. The campaign website describes how dead batteries (also referred to as 'zombie batteries') thrown away in the general rubbish, or mixed with recyclables, can be dangerous, and includes footage of fires from lithium-ion batteries at recycling and waste management facilities.³²

SOURCES

³⁰ https://assets.publishing.service.gov.uk/government/uploads/system/uploads/attachment_data/file/1155246/opss-delivery-report-2021-22.pdf

³¹ <https://www.eunomia.co.uk/reports-tools/cutting-lithium-ion-battery-fires-in-the-waste-industry/>

³² <https://www.takecharge.org.uk/why-binned-batteries-can-be-dangerous/>



Other suggested solutions include banning lithium-ion batteries from the residual and mixed recycling waste streams, introducing a deposit return scheme (DRS) for batteries, and making battery manufacturers pay for the costs of dealing with the fires their products cause.

The British Metals Recycling Association (BMRA) is now calling for a government-supported campaign to better inform the public on safe use and the hazards involved in the disposal of lithium-ion batteries. They also suggest that local authorities should carry out kerbside collections.³³

The Bicycle Association, in partnership with European Recycling Platform UK, has announced its intention to set up a national electric bike battery collection and recycling programme.³⁴ The programme will mirror those that exist in other countries, where a national network of retailers act as collection points for customers with expired or faulty batteries.

RECOMMENDATIONS

- Government should promote and support the 'Take Charge' campaign and other online resources to ensure that consumers have appropriate information about responsible and safe battery recycling.
- Local government should introduce kerbside collections for battery recycling, including e-micromobility batteries.
- Enhanced national regulation for recycling is needed to reduce the incidence of fires from the incorrect disposal of batteries. The Department for Environment, Food and Rural Affairs and the regulators should consider introducing regulatory measures requiring more prominent markings on batteries. These should include cell chemistry, how to dispose of batteries safely and warnings of the dangers of not disposing responsibly.

SOURCES

³³ <https://www.recyclemetals.org/newsandarticles/for-too-long-it-has-been-ignored.html>

³⁴ <https://www.bicycleassociation.org.uk/news-press/ba-plans-battery-collection-trial-in-april-may-2023/>



3.0 LEGISLATION AND STANDARDS



E-bikes

In the UK, an 'electrically assisted pedal cycle' (EAPC) is a classification of e-bike that is not considered to be a motor vehicle within the meaning of the Road Traffic Regulation Act 1984 and the Road Traffic Act 1988 applicable in Great Britain.

The EAPC regulations³⁵ as amended³⁶ set out the requirements that EAPCs must satisfy. As long as the e-bike meets all of the criteria, a licence to ride one is not needed and it does not need to be registered, taxed or insured.

- The bike must have pedals that can be used to propel it.
- The motor maximum continuous rated power must not exceed 250 watts.
- The motor should not be able to propel the bike when it's travelling more than 15.5 miles per hour.
- The bike must show either the power output or the manufacturer of the motor.
- The bike must show the battery's voltage or the maximum speed of the bike.
- The rider must be aged 14 or over.

An e-bike that meets the EAPC requirements is classed as a normal pedal bike. This means it can be ridden on cycle paths and anywhere else pedal bikes are allowed.

E-bikes that fall outside the EAPC rules are defined as motor vehicles on UK roads and need to be 'approved' to the necessary technical requirements before they can be used. This will normally be established by 'type approval', at the manufacturing stage, but importers and individuals can seek approval at any time. The Vehicle Certification Agency is responsible for issuing the UK type approvals on behalf of the Secretary of State for Transport. The vehicle should have a plate showing its type approval number. In addition, the user will need to have a valid driving licence and insurance, and must wear a motorcycle helmet.

The only exemption to this type approval requirement is for e-bikes produced since 2016 that can be propelled without pedalling (a 'twist and go' EAPC) if the throttle feature is limited to 3.7 miles per hour, to help gain momentum from a stationary position.

SOURCES

³⁵ <https://www.legislation.gov.uk/uksi/1983/1168/contents/made>

³⁶ <https://www.legislation.gov.uk/uksi/2015/24/contents/made>

Any e-bike that offers a power assist to a higher speed than 15.5 miles per hour, or has a motor more powerful than 250 watts, is classified as a moped when ridden on the roads.

Any e-bike that offers a power assist to a higher speed than 15.5 miles per hour, or has a motor more powerful than 250 watts, is classified as a moped when ridden on the roads. The Motorcycle Industry Association (MCIA) and the Bicycle Association of Great Britain (BA) are concerned that some sellers are unaware of, or ignoring, the rules surrounding high powered electric bicycles.³⁷ Even if the e-bike can be switched between higher and EAPC compliant power settings, it is classified according to its highest power rating. A higher power e-bike purchased for off-road use can only go where regular motocross bikes are legally permitted to go. They cannot be used on roads, common land or cycleways.

Consumers may not be fully aware of the legal restrictions that apply to the use of off-road e-bikes. Under the Consumer Protection from Unfair Trading Regulations 2008 (CPRs), retailers are obliged to disclose information that might affect a consumer's decision to buy, even if the consumer does not ask for it. Retailers should therefore make it clear to customers that the e-bike they buy may have restrictions on its use and capability.

E-scooters

According to the European Transport Safety Council, in the UK, **total imports by November 2022 were over 1.3 million.**³⁸

In the UK, e-scooters are classified as 'powered transporters' or 'personal light electric vehicles (PLEVs)'. These terms are used to cover a variety of novel and emerging personal transport devices powered by a motor, including e-scooters. There is no specially designed legal regime for the use of e-scooters. As a result, they are covered by the same laws that apply to all motor vehicles.

The definition of 'motor vehicle' as set out in the Road Traffic Act 1988 is "any mechanically propelled vehicle intended or adapted for use on roads".

In principle, for an e-scooter to be used on public roads lawfully, they would need to meet a number



of different and challenging legal requirements. These include insurance, conformity with technical standards, vehicle tax and licensing. This effectively renders their use illegal, despite the ubiquity of such devices on city streets.

Approximately 4,000 unlawfully used scooters were seized in 2021, and 1,100 were confiscated in 2022.

In a response to a 'Prevention of Future Deaths Report'³⁹ published by the East London Coroner, following the death of a 14-year-old in March 2022, the Metropolitan Police Service reported that approximately 4,000 unlawfully used scooters were seized in 2021, and 1,100 were confiscated in 2022. The Department for Transport, in their response to the report, raised concerns that some manufacturers and retailers of e-scooters do not always provide prominent warnings that these private e-scooters are illegal to use on public roads and land. They reported that, by February 2023, approximately 60 retailers had been found to be selling without the full and proper warnings, and the Minister of State for Decarbonisation and Technology

SOURCES

³⁷ <https://www.bicycleassociation.org.uk/news-press/no-grey-areas-for-ebikes/>

³⁸ <https://etsc.eu/recommendations-on-safety-of-e-scooters/>

³⁹ <https://www.judiciary.uk/prevention-of-future-death-reports/fatima-abukar-prevention-of-future-deaths-report/>



in December 2022 had also written to micromobility retailers reminding them of the law. Halfords Group Plc, being the UK's largest retailer of motoring and cycling products and services, responded to the report by advocating a "measured and controlled" approach to any change in the law as a result of the Transport Bill, which might address the wider legalisation of e-scooters. For example, a maximum speed of 15.5 miles per hour should be set for both e-scooters and e-bikes, to harmonise the requirements and avoid disparity. Conversely, if the UK Government decides to legalise use of private e-scooters on public roads, the Parliamentary Advisory Council for Transport Safety recommends a maximum possible speed of 12.5 miles per hour (20 kilometres per hour).

The Queen's Speech on 10 May 2022 announced the UK Government's intention to introduce legislation on the future of micromobility transport as part of the Transport Bill. The government intends to create a new, low-speed, zero-emission vehicle (LZEV) category, which would be different from the cycle and motor vehicle categories. New powers could stipulate that all e-scooters sold meet certain standards concerning speed, power and lights, among other things, should they fall into this new category.



In the same way that regulations restrict the use of motor vehicles, privately owned e-scooters are prohibited from use on pavements (with special legal exceptions for mobility scooters and wheelchairs), footpaths, cycle tracks, cycle lanes on roads, bridleways or restricted byways. In addition, some spaces accessible to the public are also restricted, such as car parks, public squares, private roads, industrial areas and university campuses.

There are no statutory restrictions on the use of e-scooters on private land, which is not accessible to the public, with the permission of the landowner.

E-scooters were legalised in Belgium and Germany in June 2019 and in France regulations came into force in September of that year. Private e-scooter use is now permitted across most countries, with the UK and the Netherlands notable European exceptions. While the rental machines are set to disappear from Paris streets, privately owned e-scooters are legal in France and will still be allowed in the capital.⁴⁰

According to the European Transport Safety Council, national e-scooter rules in Europe vary considerably. Several European Union countries have set standards

for the e-scooters that are permitted on public roads, and have set rules for how and where they can be used. In Germany, e-scooters are already considered as a new category of motor vehicle and must be type approved. Riders are required to have insurance but, unlike mopeds, the e-scooters can be used on cycle paths. Regulations mean that all e-scooters should have a maximum speed of 12.5 miles per hour (20 kilometres per hour) and a maximum power of 500 watts.

A regularly updated list of the key e-scooter rules in different European countries, as provided by ETSC member organisations, can be found at: <https://docs.google.com/spreadsheets/d/14oxJ4KOWbrTsRFYeNGQb65GHtTniQ0Ob1d5QqC4SKT8/>

Manufacturers need to self-certify that their e-scooter meets specific standards of product safety before they can be sold. In the UK (as amended by the Product Safety and Metrology etc. (Amendment etc.) (EU Exit) Regulations), these are: the General Product Safety Regulations 2005, the Supply of Machinery (Safety) Regulations 2008, the Electrical equipment (Safety) Regulations 2016 and Electromagnetic Compatibility Regulations 2016.

There are also strict international standards that place controls on the safe transportation of lithium-ion cells and batteries.⁴¹ To be safely transported (by air, sea, rail or roadways), they must meet the requirements specified in Standard UN 38.3. Lithium-ion batteries are identified as a Class 9 dangerous good during transport, as a result of a potential fire hazard, and packaging must be marked accordingly (Figure 26).



Figure 26: Class 9 dangerous good labels.

SOURCES

⁴⁰ <https://www.moveelectric.com/e-scooters/paris-residents-vote-ban-rental-e-scooters>

⁴¹ <https://www.iata.org/contentassets/.../lithium-battery-guidance-document.pdf>

The role of safety standards

Standards are technical specification documents, developed and established by consensus and approved by a recognised body. They are not mandatory, unless mandated by a piece of legislation. However, they can be used to demonstrate a presumption of conformity to the safety objectives of a piece of legislation. A standard becomes a ‘designated standard’ when it has been recognised by the UK Government in part or in full by publishing its reference on GOV.UK in a formal notice of publication. By following designated standards, manufacturers can claim a ‘presumption of conformity’ with the corresponding essential requirements of the legislation. It should be noted that designated standards do not replace the essential requirements and manufacturers retain full responsibility for ensuring the applicable legislation is met.

Using standards

Where there is a designated standard that covers all of the risks associated with a particular product, the path to meeting the legislation is relatively straightforward. However, this is not always the case. For example,



e-bike conversion kits do not have a product standard, and the e-bikes standard, although listed as a designated standard, has some risks excluded from the presumption of conformity. In these cases, it is up to the manufacturer, perhaps along with the help of a test house or safety consultant, to decide on the appropriate standards to be applied to demonstrate conformity to the safety objectives of relevant legislation. The same applies to new technology that is not covered by existing standards or innovation where a product standard has not yet been created.

Safety standards applicable to products within the scope of this report include the following.

STANDARD	SCOPE
<p>BS EN 62133-2:2017+A1:2021</p> <p>Secondary cells and batteries containing alkaline or other non-acid electrolytes – Safety requirements for portable sealed secondary cells, and for batteries made from them, for use in portable applications. Part 2: Lithium systems.</p>	<p>This standard specifies requirements and tests for the safe operation of portable sealed secondary lithium cells and batteries containing non-acid electrolyte, under intended use and reasonably foreseeable misuse.</p>
<p>BS EN 50604-1:2016+A1:2021</p> <p>Secondary lithium batteries for light EV (electric vehicle) applications. General safety requirements and test methods.</p>	<p>This standard specifies test procedures and provides acceptable safety requirements removable lithium-ion battery (packs and) systems for all light EV electrically propelled vehicles, including electrically assisted cycles (EAPC classified e-bikes).</p>



STANDARD	SCOPE
BS EN 15194:2017 Cycles. Electrically power assisted cycles. EPAC Bicycles.	Specifies safety and safety-related performance requirements for the design, assembly, and testing of EPAC bicycles and subassemblies intended for use on public roads.
BS EN 17404:2022 Cycles. Electrically power assisted cycles. EPAC Mountain bikes. – Part 2: Specific requirements applicable to electric mountain bikes.	This standard supplements or modifies the corresponding clauses in EN 15194:2017, providing specific requirements for EAPC Mountain bikes.
BS EN 17128:2020 Light motorized vehicles for the transportation of persons and goods and related facilities and not subject to type-approval for on-road use. Personal light electric vehicles (PLEV) – Requirements and test methods.	This standard applies to personal light electric vehicles with or without self-balancing system totally or partially electrically powered from self-contained power sources, including e-scooters.
IEC 60335-2-114:2022 ED2 Household and similar electrical appliances. Safety. Part 2 – 114: Particular requirements for Personal-e-Transporters.	This standard deals with the electrical safety of personal e-transporters used in the private or public areas, including e-scooters.
ISO/TS 4210-10:2020 Cycles. Safety requirements for bicycles. Safety requirements for electrically power assisted cycles (EPACs).	This standard specifies safety and performance requirements for the design, marking, assembly, and testing of two-wheeled electrically power assisted cycles (EAPC classified e-bikes).

Note: The terms ‘electrically power assisted cycles’ (EPAC) and ‘electrically assisted pedal cycles’ (EAPC) are interchangeable. While international and European safety standards generally refer to EPACs, e-bikes of this classification are referred to as EAPCs in the UK.

Even where standards exist for comparable products, there may be inconsistencies in the requirements within those standards. This may be due to a legacy issue or lack of liaison between different technical committees responsible for drafting and developing interrelated standards.

For example, both IEC 60335-2-114 and BS EN 17128:2020 provide technical specifications for e-scooters. However, the National Committees of the European Electrotechnical Committee for Standardization (CENELEC) decided not to adopt IEC 60335-2-114 in Europe, as many of the technical requirement’s conflict with those in BS EN 17128:2020. Furthermore, the UK National Committee voted against the publication of EN 17128:2020 as a British Standard, as it raised concerns that certain criteria introduced into the standard are unsuitable

and do not cover state-of-the-art systems available in the marketplace. A statement to this effect is made in the National foreword to BS EN 17128:2020.⁴²

SOURCE

⁴² <https://knowledge.bsigroup.com/products/light-motorized-vehicles-for-the-transportation-of-persons-and-goods-and-related-facilities-and-not-subject-to-type-approval-for-on-road-use-personal-light-electric-vehicles-plev-requirements-and-test-methods/standard/preview>

This situation creates legal ambiguity for manufacturers and suppliers of e-scooters to the UK market, and presents challenges to regulators and test houses when assessing risk.

ISO/TS 4210-10:2020 is a good example of where the 'Technical Specification' route is used by a standardisation body to deal with work still under technical development but published for immediate use. A technical specification allows the body to bypass many of the formal approval stages required for a published standard. In this case, the technical committee responsible for its development decided to approve publication in the form of a technical specification to address rapidly developing technologies for EAPCs associated with electrical control, battery management and battery charging, amongst other things. In respect to battery charging, the specification seeks to tackle the potentially dangerous compatibility of non-proprietary systems – for example, where the battery is not designed to operate exclusively with a dedicated charger. Ultimately, the aim is that this specification will eventually be republished as an International Standard, setting out minimum requirements to be applied by manufacturers.

” To reduce the risks to consumers, it is important that all e-micromobility requirements are aligned, and where possible, consolidated to avoid fragmentation across various standards. It is also essential that standards are developed for products currently unregulated, such as for e-bike conversion kits...

To reduce the risks to consumers, it is important that all e-micromobility requirements are aligned, and where possible, consolidated, to avoid fragmentation across various standards. It is also essential that standards are developed for products currently unregulated, such as for e-bike conversion kits, to establish a gap-free and robust safety framework.

RECOMMENDATIONS

- UK Government should deliver a consumer awareness campaign to clarify legislation around the use of private e-scooters.
- Trading Standards should prioritise market surveillance of businesses marketing e-micromobility products to tackle mis-selling practices.
- The Office for Product Safety and Standards (OPSS) should adopt the technical specification ISO/TS 4210-10: 2020. Cycles. Safety requirements for bicycles Part 10: Safety requirements for electrically power assisted cycles (EPACs) as a designated standard to mitigate risks of dangerous compatibility/charging.
- The requirements specified in product standards for e-micromobility need to be better aligned. The Office for Product Safety and Standards should mandate a review of the product safety standards referenced in this report for inconsistencies and conflicting specifications that could otherwise lead to legal uncertainty.
- UK standardisation bodies must establish consistent charging protocols for e-micromobility products to be adopted by industry.
- UK Government should mandate the development of a product standard, specific to conversion kits and associated components.

4.0 SHARED E-MICROMOBILITY IN THE UK



The rise in the many types of e-micromobility vehicles across the globe is evident in all major towns and cities. A micromobility report carried out in 2022 put the global market value of micromobility to be about £37 billion in 2020, with expectations to reach over £169 billion by 2030.⁴³ Although all of the various types of e-micromobility have been available to buy and own, the likes of e-scooters remain effectively illegal to use on public roads and pavements. This has led to trials of shared e-mobility schemes being developed in order to obtain data and analyse the best approach to achieving transport decarbonisation and encouraging the shift from private cars, improving air quality, and reducing congestion.

Many local authorities have already made notable progress in establishing shared micromobility schemes that provide rental services for e-bikes, e-scooters and cargo bikes.

According to the national shared transport charity, Collaborative Mobility UK (CoMoUK), by the end of September 2022, there were 43 locations served by bike share on-street self-service schemes in the UK, making almost 12,000 e-bikes available for hire. In the 12 months to September 2022, scheme operators recorded close to 20 million hires, which equates to an average of 54,285 rides per day. By the end of 2022, 33 e-cargo bikes were available via bike sharing.⁴⁴

To support a green recovery from the COVID-19 pandemic and to gather evidence to help inform future policy and regulation, the Department for Transport (DfT) made regulations allowing trials of rental e-scooters. The first trial started in July 2020, and a total of 32 trials across 55 areas have been

” The Department for Transport (DfT) has allowed trials of rental e-scooters. Since July 2020, a total of 32 trials across 55 areas have been delivered by 12 operators. 14.5 million trips had been made up till the end of December 2021, and some 23,000 e-scooters had been deployed.⁴⁵

delivered by a total of 12 e-scooter operators. The DfT reports that 14.5 million trips were made since the trials started in July 2020 until the end of December 2021, and some 23,000 e-scooters had been deployed.⁴⁵

SOURCES

⁴³ <https://www.alliedmarketresearch.com/micro-mobility-market-A11372>

⁴⁴ <https://www.como.org.uk/documents/bike-share-annual-report-uk-2022>

⁴⁵ <https://www.gov.uk/government/publications/national-evaluation-of-e-scooter-trials-report>

The original deadline for the end of the e-scooter trials was 30 November 2021. Officially, this was extended to 30 November 2022, although participating councils can extend the trials until the end of 2024.

Scheme rules require e-bikes to meet the EAPC requirements. Trial e-scooters will continue to be classified as motor vehicles and require the user to be covered by motor vehicle insurance and hold a valid driving licence. Rental operators are responsible for ensuring an insurance policy is in place that covers users of the vehicles. However, as part of the trials, the DfT has defined a sub-category for an e-scooter being a motor vehicle that:

- Is fitted with no motor other than an electric motor with a maximum continuous power rating of 500 watts and is not fitted with pedals that are capable of propelling the vehicle;
- Is designed to carry no more than one person;
- Has a maximum speed not exceeding 15.5 miles per hour;
- Has two wheels, one front and one rear, aligned along the direction of travel;
- Has a mass including the battery, but excluding the rider, not exceeding 55kg;
- Has means of directional control via the use of handlebars that are mechanically linked to the steered wheel; and
- Has means of controlling the speed via hand controls and a power control that defaults to the 'off' position.

In addition to the regulatory provisions above, local authorities may wish to specify their own additional requirements for the trials. For example, in London, riders must be 18 or over, the speed limit is capped at 12.5 miles per hour (which can be reduced to 8 miles per hour in 'go slow' areas), and lights at the front and rear of the e-scooter must remain on throughout the rental.⁴⁶

Existing national regulations have been further amended to allow the trials to take place. Trial e-scooters have been made exempt from the requirement to wear a motorcycle helmet, vehicle registration and licensing and vehicle type approval. They are permitted on the road and in cycle lanes and tracks, where possible.

For product safety, the DfT set minimum technical



requirements for trial e-scooters in the form of 'special orders' that modify the provisions of the Road Traffic Act 1988 and that operators are required to demonstrate conformity to. They cover general safety, anti-tampering, audible warning, braking, mass and dimensions, lighting and reflectors, labelling, stands, towing, tyres, stability and electrical safety.

The requirements for electrical safety specify that the vehicle and its components of the electrical system including the battery shall be so designed, constructed and fitted as to:

- Minimise and protect against the risk of electrolyte leakage, fire, explosion and electric shock; and
- Ensure electromagnetic compatibility.

These requirements are generic and lack specifics. As a result, many authorities have employed the services of third-parties that can deliver advisory services for e-micromobility operations, such as <https://www.micromobilitypartners.com/>. In London, operators of e-scooter schemes were chosen based on their ability to meet strict safety requirements and high operating standards. For example, the e-scooter batteries can be monitored to ensure they meet fire safety regulations,⁴⁷ although there appears to be no publicly available details on how this was assessed.

The DfT's minimum technical requirements should include a fire safety risk assessment that considers all aspects of battery charging, storage, use and foreseeable abuse conditions.

Clearly, any shared e-micromobility scheme should be safe by design with safety principles embedded in its operations. Vehicles which are identified as unsafe should be removed and promptly made unavailable to hire.

SOURCES

⁴⁶ <https://tfl.gov.uk/modes/driving/electric-scooter-rental-trial>

⁴⁷ <https://tfl.gov.uk/modes/driving/electric-scooter-rental-trial>



Operating models

A report exploring shared micromobility in the UK, commissioned by the Local Government Association's Economy, Environment, Housing and Transport Board, found that most schemes are privately owned and operated in partnership with local councils and the transport authorities.⁴⁸

Currently, no publicly owned and operated hire schemes exist in the UK.

Parking models vary regionally; the benefits and challenges of which are explored in more detail by CoMoUK.⁴⁹ There are four primary parking models currently in operation in the UK. Docking stations (with or without charging capability), allocated parking racks, geofenced locations and free-floating where vehicles can be parked anywhere in the operating area.

The most widely adopted parking model, for e-scooters in particular, utilises geofencing technology to control drop-off and pick-up locations that can be either marked bays or virtual docks (no markings). While this model enables the ability to better manage parking compared to free-floating, there is still potential for pavements to be cluttered with vehicles causing hazardous obstructions (Figure 27).

Although this model can be implemented relatively quickly and at low cost, it introduces redistribution challenges and potential incidents of damage (including criminal damage), which could compromise the safety of the battery and increase the probability of other safety issues. Robust maintenance, quality and safety systems need to be in place to mitigate risk.

The charging and servicing strategy for rental e-scooters can be a significant component of their environmental impact. Research suggests that 43% of the lifetime carbon impact can be attributed to the daily collection and redistribution of e-scooters.⁵⁰ Operators have established new measures to reduce the environmental impact, including the introduction of swappable batteries, thereby removing the need for vehicle collection for recharging. An added benefit is that, with the battery removed, safety checks for signs of damage and deformation of the battery can be carried out more easily.



Figure 27: Photo of rental e-bikes cluttering street causing obstruction on pavement.

SOURCES

⁴⁸ <https://www.local.gov.uk/publications/shared-micromobility-within-uk>

⁴⁹ [Scooter terminology and operational models \(13.07.20\).pdf](#)

⁵⁰ <https://iopscience.iop.org/article/10.1088/1748-9326/ab2da8>



E-scooter trials evaluation

The DfT's National evaluation of e-scooter trials findings report⁵¹ contains very little detail around the safety management systems employed by the local authorities and operators, or an evaluation of their impact on safety.

Within the minimum safety standards set by the DfT, local authorities were able to apply a degree of flexibility to some aspects of contracts set up with operators. Such flexibility can have an impact on safety, but the report offers no evaluation of such an impact.

The report offers no evaluation of the impact of these differences in respect to safety.

The report notes that "gathering reliable safety data was a challenge" and should therefore be taken as indicative. Casualty data collected by the DfT through the STATS19 reporting system was used to estimate a rental e-scooter casualty rate. Data collected through this reporting system relies on the police capturing the information that an incident involved an e-scooter in the 'open text box' as there is currently no 'e-scooter' category in the selection modes (they are included in 'other vehicles'). Additionally, there is no ability to differentiate between rental or private e-scooters, so the data cannot be assumed to be directly applicable to the trials.

It is clear from these data collection deficiencies that there is potential for more learning to be gained through improved data collection methods and further analysis of the collected data.

RECOMMENDATIONS

- The Department for Transport must ensure that the minimum technical requirements regarding battery safety are specific and include a fire safety risk assessment.
- The Department for Transport (DfT) should ensure that the process of e-scooter trial data collection for all incidents involving safety is more effective, and that objective measures are implemented to better evaluate the adequacy of the DfT's minimum safety requirements.

SOURCE

⁵¹ <https://www.gov.uk/government/publications/national-evaluation-of-e-scooter-trials-report>



5.0 OUR INVESTIGATIONS

E-bike and e-scooter chargers available online

Online marketplaces continue to host highly dangerous electrical goods, making them freely available for sale to the public.

In 2022, an investigation carried out by Electrical Safety First (ESF), identified mains chargers designed to charge e-bike batteries that could start devastating fires. We found nearly 60 listings by third-party sellers, across four of the biggest online marketplaces.

The listed products were predominantly advertised as e-bike chargers, whilst others were for multiple use, designed to charge the batteries of e-scooters or hoverboards.

The chargers all failed to meet the UK plug standard, with many appearing to have no fuse, shedding doubt as to the overall safety of the product, including the quality and safety of internal components (Figure 28). Plugs without a fuse have no means of cutting off the electricity in the event of a fault in the supply lead, leaving the consumer exposed to a serious risk of fire. An incorrect plug is a sign that the charger has not been adequately tested to the necessary

” Plugs without a fuse have no means of cutting off the electricity in the event of a fault, leaving the consumer exposed to serious risk of fire.



safety standards, increasing the risk of further hidden dangers, including electric shock.

The number of substandard chargers found on each marketplace can be found below:

- Amazon: 13 listings
- eBay: 21 listings
- Wish.com: 13 listings
- AliExpress: 12 listings

As a result of our investigation and action from the respective online marketplaces, all of the listings were removed and a further 201 additional listings were removed following a sweep for clover-shaped plugs, carried out by eBay on their platform.



Charger Adapter 48V 5A Charger E-bike Scooter Battery Charger 54.6 V Lithium Battery Pack Plug Power Cable, Charger (Color : 2A, Size : F)

£35⁶⁸

Size: F

- A
- B
- C
- F
- G
- E
- D

Colour: 2a



- The circuit board material in the lithium battery charger is FR-4, small, light, high-efficiency, stronger and more stable.
- Fast charging design, maximum output 54.6V, suitable for 48V lithium-ion battery. The 5A charger charges faster and saves you time! Wide input voltage range: 110-240V,

£35⁶⁸

£3 delivery August 20 - 26. Details

Select delivery location

In stock.

Quantity: 1

Add to Basket

Buy now

Secure transaction

Dispatches from Sold by

Return Policy: Returnable within 30 days of receipt

Add Extra Protection? Check if this cover meets your needs:

Figure 28: Example of non-compliant e-bike charger with unfused plug and selection of connectors.



Figure 29: Photos of test sample during and post thermal runaway event from a simulated nail penetration test.



Figure 30: Photos of test sample during a thermal runaway event after being incorrectly charged.

Battery testing

As part of our ongoing research into lithium-ion batteries, ESF recently commissioned some testing at BRE. The testing delivered valuable information and video footage on how lithium-ion batteries behave during tests based on those specified in BS EN 62133-2: 2017 +A1: 2021, and potentially what happens when the batteries enter a state of thermal runaway. The tests in this standard simulate situations of normal use and foreseeable misuse.

The research examined various types of e-bike and e-scooter batteries, including enclosed types, unenclosed types and batteries incorporated in a supplied e-scooter. The video footage and temperature data generated has been used to inform this report, create consumer guidance, raise awareness of lithium-ion battery fires and promote the safe use and charging of e-bikes and e-scooters.

The tests were carried out in two phases. The first phase tested the batteries in their original state (as supplied); the second phase included fault conditions that the batteries might encounter during their life cycle or DIY modifications, such as those being promoted online.

The first phase of testing included impact (free fall) tests, thermal abuse tests, short circuit tests, overcharging tests and mechanical crush and nail penetration tests (Figure 29). The second phase concentrated on short circuit and overcharging of the batteries, with simulated faults applied, or with the batteries modified as depicted online (Figure 30). Each phase of the testing resulted in at least one occurrence of thermal runaway.

[VIEW BATTERY TEST VIDEOS](#)

6.0 STRATEGIES TO MITIGATE FIRE RISK



There is no single solution to the safety issues surrounding e-micromobility – apart, perhaps, from banning the sale and use of e-bikes and e-scooters completely. This may seem an extreme step, but it may be the only solution if measures are not put in place to reduce the number of fires associated with these vehicles and the current danger to public safety.

The imminent ban of all rental e-scooters in Paris and the recent e-scooter ban across the entire TFL public transport network, following a number of fires on its premises and services, are stark examples of actions taken due to lack of regulation, specifically around safety standards.⁵²

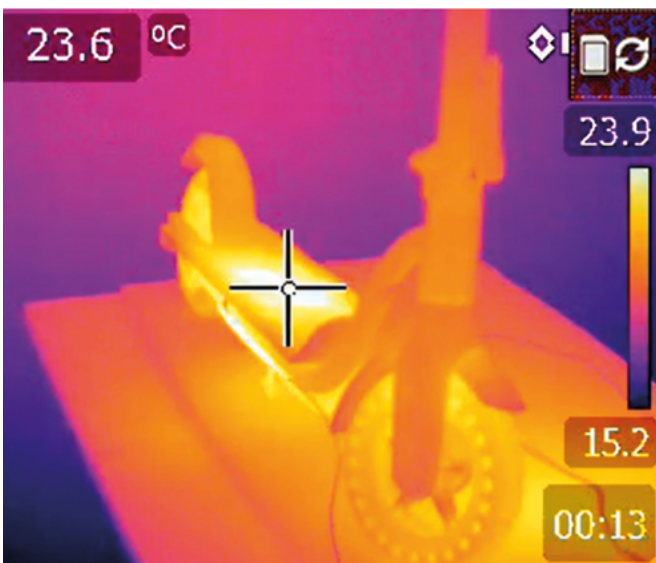

In New York, an alternative approach has been taken. E-bikes, e-scooters and separate batteries will be required to have mandatory third-party certification to appropriate Underwriters Laboratories (UL) standards. This new law, passed in March 2023, is being introduced following a significant increase in lithium-ion battery fires in 2022, largely associated with e-bikes. It has been reported that an e-bike or e-scooter battery causes a fire in the city on average four times a week.⁵³ Any company selling, leasing or distributing e-micromobility vehicles, such as e-bikes

or e-scooters, has until September 2023 to obtain certification from an accredited testing laboratory. Sellers violating the rules risk fines and prosecution. Alongside the new rules, a fire marshal task force and consumer campaigns are incentivising consumers to purchase safe and legal e-micromobility vehicles, as well as adopting outdoor micromobility storage and charging solutions.

A regulatory approach

The solutions for the UK must come from a range of stakeholders, including regulatory bodies, standards committees, and campaigning bodies, as well as delivery firms, their employees, riders and consumers. If mandatory third-party certification is determined to be the most appropriate route to safer e-micromobility, it may be possible to utilise the 'EC-type examination' or full quality assurance provisions of the Supply of Machinery (Safety) Regulations 2008. The latter currently applies to some types of e-micromobility, such as ready-built e-bikes, for which self-declaration of conformity is currently permitted in the Regulations. EC type examination or full quality assurance procedures require the intervention of a UK Approved Body to confirm conformity with the Essential Health and Safety Requirements (EHSRs).

SOURCE

⁵² <https://tfl.gov.uk/info-for/media/press-releases/2021/december/tfl-announces-safety-ban-of-e-scooters-on-transport-network>

⁵³ [https://legistar.council.nyc.gov \(docX\)](https://legistar.council.nyc.gov (docX))

Time for change

Alternatively, a new, low-speed, zero-emission vehicle (LZEV) category, different from the existing cycle and motor vehicle categories, could allow the implementation of new powers stipulating specific third-party approval standards concerning speed, power and lights, among other things.

Perhaps a more radical approach would be to mirror some of the legislative changes taking place in the EU. On the 25 April 2023, the Council of the European Union adopted the General Product Safety Regulation (GPSR), which will replace the General Product Safety Directive. The new rules came into force on 13 June 2023 and will be fully implemented by 13 December 2024. They introduce the concept of 'implementing acts': if the Commission becomes aware of a product, or a specific category or group of products, presenting a serious risk to the health and safety of consumers, it may take any appropriate measures, either on its own initiative or upon request of Member States, by means of implementing acts, adapted to the gravity and urgency of the situation. Adopting this measure in the UK, perhaps through a revision to the General Product Safety Regulations 2005, could generate third-party conformity assessment requirements for specific aspects of e-micromobility products.

State-of-the-art

The batteries in e-bikes and e-scooters remain less safe than those used in electric vehicles (EVs), energy storage systems and industrial batteries, despite using similar technologies. This discrepancy may be due to the lack of regulation in the e-bike and e-scooter industry, but may also, in part, be due to the way technologies are used and how they are integrated with protective systems. For example, on board an electric car, the charging of batteries is strictly controlled by electronics; it is not left to the consumer to select a compatible charger.

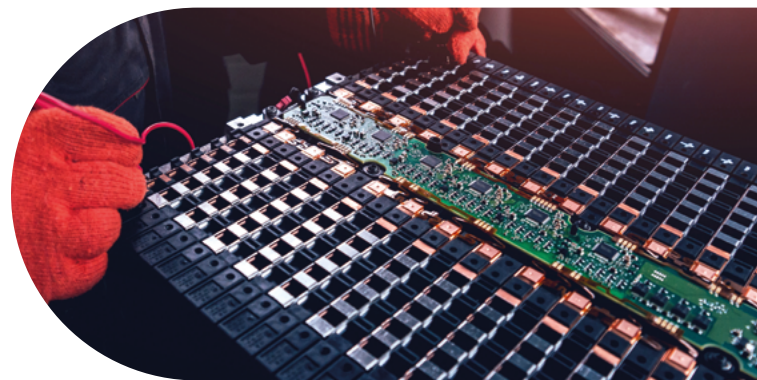

The safety of a lithium-ion battery, especially when mitigating the risk of thermal runaway, depends not only on the cell chemistry but also its design, the configuration of multiple cells within a battery, the thermal management strategy, charging protocols and the quality of the battery management system (BMS). It also depends on the quality and control of the manufacturing process.



The automotive industry has supplied some methods for preventing heat build-up, such as providing additives within battery cells. Whilst the EV sector has large budgets and invests heavily in research and development, there are some lessons in battery safety that could be borrowed for the e-bike and e-scooter industries.

Improvements in technology can be shared across industries through standards and legislation. Other solutions may lie in external fire suppression systems, such as intumescent foam encapsulation systems or fire suppression bags and enclosures for external charging. However, these solutions would themselves

need to be subject to appropriate specific product safety standards – which do not currently exist.

Authorities could also consider restricting the types of battery that can be used in e-bikes and e-scooters. Alternative chemistries, such as lithium iron phosphate (LiFePO₄) and lithium titanate (LTO) or li-titanate (Li₄Ti₅O₁₂), have demonstrated that they are less prone to thermal runaway than some of the commonly used chemistries. Emerging technologies, such as solid-state constructions, have also shown promise. Any restrictions applied should not prohibit advances in technology that could capitalise on the development of safer and more effective power systems.

Currently, there is no requirement for the type of cell chemistry used to be marked on a battery. Doing so could help ensure consumers make informed purchasing decisions where safety is a key consideration. It would also facilitate more effective recycling.



RECOMMENDATIONS

- If the road use of e-scooters is legalized, the UK Government should consider tighter regulation on use, functionality and design, as recommended in this report.
- The Office for Product Safety and Standards should consider whether e-micromobility and lithium-ion batteries that power them should be subject to mandatory third-party certification and approval processes to reach the UK market.
- The Office for Product Safety and Standards should invest in research into safer forms of e-micromobility battery systems.
- UK Government should mandate the development of a consumer product standard, specific to fire resistant charging containers for e-micromobility batteries.
- The Department for Environment, Food and Rural Affairs and the regulators should consider introducing regulatory measures requiring more prominent markings on batteries to include cell chemistry.

SUMMARY OF RECOMMENDATIONS

CONSUMER EDUCATION

- Government, fire and rescue services and consumer protection organisations should run consumer awareness campaigns about the risks associated with e-bikes and e-scooters being stored or charged in certain residential locations, such as emergency fire exit routes.
- Further consumer education is needed around the risks and liabilities of modifying a pedal bike to an e-bike using a conversion kit.
- Government must raise awareness of the legal implications of converting or purchasing an e-bike beyond the EAPC rules.
- Government, fire and rescue services and consumer protection organisations should launch a consumer education campaign that reinforces the messages around safe charging practices.
- Government should promote and support the Take Charge campaign and other online resources to ensure that consumers have appropriate information about responsible and safe battery recycling.
- Government should deliver a consumer awareness campaign to clarify legislation around the use of private e-scooters.

POLICY

- The Office for Product Safety and Standards should consider whether e-micromobility and lithium-ion batteries that power them should be subject to mandatory third-party certification and approval processes to reach the UK market.
- UK Government should mandate the development of a consumer product standard, specific to fire resistant charging containers for e-micromobility batteries.
- If the road use of e-scooters is legalised, the UK Government should consider tighter regulation on use, functionality and design, as recommended in this report.
- Government should consider prohibiting the sale of universal chargers for e-micromobility vehicles or introduce standards for non-proprietary charging systems.
- The Department for Transport must ensure that the minimum technical requirements regarding battery safety are specific and include a fire safety risk assessment.
- The Office for Product Safety and Standards should invest in research into safer forms of e-micromobility battery systems.



- Local government should introduce kerbside collections for battery recycling, including e-micromobility batteries.
- Trading Standards should prioritise market surveillance of businesses marketing e-micromobility products to tackle mis-selling practices.
- Delivery service businesses should take responsibility and liability for the safety of their riders who use e-micromobility vehicles. They should also consider providing e-bikes or running an incentive scheme to encourage their riders to use company approved e-micromobility vehicles.
- Delivery service riders who use e-micromobility vehicles must declare that their mode of transport is road legal.
- Delivery service businesses should stipulate e-micromobility specifications and maintenance requirements.
- Delivery service businesses should consider providing a safe charge bag or similar fire-protection enclosure to riders who use e-micromobility vehicles.

DATA COLLECTION

- The Home Office should expand the current Incident Recording System to become a robust, up-to-date national fire data collection system that enables fires to be specifically attributed to e-micromobility batteries.
- The Department for Transport (DfT) should ensure the process of e-scooter trial data collection for all incidents involving safety is more effective, and they should implement objective measures to better evaluate the adequacy of the minimum safety requirements.

STANDARDS & REGULATIONS

- UK Government should mandate the development of a product standard, specific to conversion kits and associated components.
- The Office for Product Safety and Standards (OPSS) should adopt the technical specification 'ISO/TS 4210-10: 2020. Cycles. Safety requirements for bicycles Part 10: Safety requirements for electrically power assisted cycles (EPACs)' as a designated standard to mitigate risks of dangerous compatibility and charging.
- UK standardisation bodies should consider the marking requirements for the e-micromobility standards, so that the battery or charging port is marked with the voltage required for charging.
- The Department for Transport should consider introducing within the EAPC general requirements a 60V DC limit on all electrical circuits including the charger to protect against electric shock. The same limitation should also apply to any future requirements that legalise the use of private e-scooters on roads. This aligns with the voltage limit specified in the Technical Specification – Safety requirements for electrically power assisted cycles [EPACs] ISO/TS 4210-10:2020.

- The Department for Transport should consider implementing the safety-in-design features recommended in this report as the industry standard, alongside the recommendations on safety of e-scooters from the European Transport Safety Council (ETSC) and the UK Parliamentary Advisory Council for Transport Safety (PACTS) [here](#).
- The requirements specified in product standards for e-micromobility need to be better aligned. The Office of Product Safety and Standards should mandate a review of the product safety standards referenced in this report for inconsistencies and conflicting specifications that could otherwise lead to legal uncertainty.
- Enhanced national regulation for recycling is needed to reduce the incidence of fires from the incorrect disposal of batteries. The Department for Environment, Food and Rural Affairs and the regulators should consider introducing regulatory measures requiring more prominent markings on batteries: These should include cell chemistry, how to dispose of batteries safely and warnings of the dangers of not disposing responsibly.
- UK standardisation bodies must establish consistent charging protocols for e-micromobility products to be adopted by industry.

ONLINE MARKETPLACES

- UK Government should introduce legislation to make online marketplaces take reasonable steps to prevent or delist unbranded and potentially non-compliant conversion kits.
- The Office for Product Safety and Standards should undertake a review of various manufacturing and consumer markets supplying dangerously compatible charging products, consider introducing tighter controls and prioritise enforcement to prevent these products from being made available on the UK market.



ANNEX A

Media reports of fires caused by e-bikes and e-scooters in the UK between April 2022 and March 2023

Media source	Location	Link
Southern Evening Echo	Southampton	E-scooter on charge catches fire in Southampton forcing boy to flee his bedroom
Evening Standard	Shepherds Bush	Shepherds Bush flats blaze was ignited by charging e-bike, says resident
Ham&High	Finchley	Firefighters renew e-scooter warning after Finchley blaze Ham & High (hamhigh.co.uk)
GB News	Walthamstow	E-bike warning issued after battery fire leaves five in hospital (gbnews.com)
The Times	Southwark	London Bridge fire: Exploding ebike blamed for blaze (thetimes.co.uk)
Evening Standard	Finchley	E-bike battery explosion destroys London roof terrace, prompting safety warning Evening Standard
FPA	Stepney Green	E-bike causes flat fire in Stepney Green Fire Protection Association (thefpa.co.uk)
Sky News	Bristol	Electric bike caused Bristol tower block fire which resulted in man's death, investigators say UK News Sky News
Mirror	Belfast	Two rescued from house fire caused by electric bike plugged in overnight - Mirror Online
UKNIP247	Hayes	Firefighters have issued another e-bike safety warning after a house fire on Balmoral Drive in Hayes in the early hours — UKNIP
Crewe Nub News	Crewe	Firefighters tackle serious West End flat fire caused by electric bike charger fault Local News News Crewe Nub News
BBC News	Oldham	Failsworth fire caused by e-bike batteries blows out house window - BBC News
The Scottish Sun	Elgin	Family's heartache as inferno sparked by dodgy electric bike destroyed home of 22 years The Scottish Sun

Media source	Location	Link
Evening Standard	Bethnal Green	E-bikes catch fire in Bethnal Green second-hand shop Evening Standard
The Chiswick Herald	Ealing	Firefighters Rescue Man from West Ealing Blaze (chiswickherald.co.uk)
BBC News	Isle of Man, Peel	Warning after two rescued from fire caused by electric bicycle - BBC News
In your area news	Runcorn	Electric scooter charging blamed for 'serious' house fire in Runcorn InYourArea News
BBC News	Cumbria	Whitehaven house fire: Warning after e-bike battery failure - BBC News
BBC News	Merseyside	Litherland e-bike charger fire: Second man dies
Bracknell News	Reading and Slough	Berkshire e-bike and e-scooter fires on the rise Bracknell News
BBC News	Southwark	E-bike safety: Mother calls for more regulations after daughter's death - BBC News
Wigan Today	Wigan	E-bike batteries blamed for Wigan borough house fire Wigan Today
London Fire Brigade	Lewisham	Flat fire - Lewisham London Fire Brigade (london-fire.gov.uk)
Your Harlow	Harlow	Warning over second hand batteries after e-scooter fire in Harlow
UKNIP247	Brighton	One injured after electric scooter fire in Kemptown — UKNIP
Tower Hamlets	Aldgate and Limehouse	Tower Hamlets Council and London Fire Brigade issue warning after two e-bike fires rip through flats in under 48 hours
BBC News	Frome	Frome couple praise community support after house fire - BBC News
Bolton News	Bolton	Bolton: Man rescued from Tonge Fold house fire The Bolton News
Belfast live	Belfast	NIFRS warning after blaze 'caused by e-bike charging overnight' - Belfast Live
Ham&High	West Hampstead	E-bike battery safety warning after West Hampstead flat fire Ham & High (hamhigh.co.uk)
ebiketips	Luton	Luton fire was caused by "home-made" e-bike conversion electric bike reviews, buying advice and news - ebiketips (road.cc)



Media source	Location	Link
Rotherham advertiser	Thurnscoe	E-bike in flames puts fire crews on alert (rotherhamadvertiser.co.uk)
The Guardian	Tower hamlets	Residents demand independent inquiry into council's role before fatal fire London The Guardian
Yahoo News	Deptford	Firefighters issue e-bike warning after rescuing man from Deptford flat fire (yahoo.com)
Southwark News	Honor Oak	Three children and four adults escape Honor Oak flat fire, believed to be caused by faulty e-bike charger - Southwark News



Bibliography

Allied Market Research, 2022. *Micro Mobility Market A11372*. [Online] Available at: <https://www.alliedmarketresearch.com/micro-mobility-market-A11372> [Accessed 19 June 2023].

Amazon, 2022. *Amazon expands electric cargo bike deliveries in Manchester and London*. [Online] Available at: <https://www.aboutamazon.co.uk/news/sustainability/amazon-expands-electric-cargo-bike-deliveries-in-manchester-and-london> [Accessed 19 June 2023].

BBC, 2022. *Electric bike caused fatal Bristol flat fire, council says*. [Online] Available at: <https://www.bbc.co.uk/news/uk-england-bristol-63031602> [Accessed 19 June 2023].

Bicycle Association, 2016. *No Grey Areas for E-Bikes*. [Online] Available at: <https://www.bicycleassociation.org.uk/news-press/no-grey-areas-for-ebikes/> [Accessed 19 June 2023].

Bosch, n.d. *200 YEARS OF THE BICYCLE*. [Online] Available at: <https://www.bosch-ebike.com/en/everything-about-the-ebike/stories/200-years-of-bicycle-history> [Accessed 26 May 2023].

BSI, 2020. *BS EN 17128: 2020 Light motorized vehicles for the transportation of persons and goods and related facilities and not subject to type-approval for on-road use. Personal light electric vehicles (PLEV). Requirements and test methods*, London: s.n.

Cargo bike share, 2023. *cargobikeshare*. [Online] Available at: <https://www.cargobikeshare.cc/> [Accessed 19 June 2023].

Chartered Trading Standards Institute (CTSI), 2023. *CTSI issues warning about e-bike and e-scooter battery fires*. [Online] Available at: <https://www.tradingstandards.uk/news-policy/news-room/2023/ctsi-issues-warning-about-e-bike-and-e-scooter-battery-fires/> [Accessed 19 June 2023].

City of New York, 2022. *E-bikes and Lithium-ion Battery Safety*, New York: City of New York.

CoMoUK, 2020. *e-scooter terminology and operational*

models. [Online] Available at: [Scooter terminology and operational models.pdf](#) [Accessed 19 June 2023].

CoMoUK, 2021. *Annual Bike Share Report 2021*, Leeds: CoMoUK.

Department For Transport, 2016. *Shared Electric Bike Programme Report*, London: Department For Transport.

Department For Transport, 2018. *funding boost for green last mile delivery bikes*. [Online] Available at: <https://www.gov.uk/government/news/funding-boost-for-green-last-mile-delivery-bikes> [Accessed 19 June 2023].

Department for Transport, 2022. *National statistics National Travel Survey 2021: Mode share, journey lengths and public transport use*. [Online] Available at: <https://www.gov.uk/government/statistics/national-travel-survey-2021/national-travel-survey-2021-mode-share-journey-lengths-and-public-transport-use> [Accessed 19 June 2023].

Environmental Services Association, 2022. *Why binned batteries can be dangerous*. [Online] Available at: <https://www.takecharge.org.uk/why-binned-batteries-can-be-dangerous/> [Accessed 31 May 2023].

Eunomia, 2021. *lithium-ion-battery-waste-fires-costing-the-uk-over-100m-a-year*. [Online] Available at: <https://www.eunomia.co.uk/lithium-ion-battery-waste-fires-costing-the-uk-over-100m-a-year/> [Accessed 07 June 2023].

European Transport Safety Council, 2023. *Recommendations on Safety of E-scooters*, London: European Transport Safety Council.

GIBSON, A. H. C., 1916. *patents.google.com/patent/US1192514A/en*. USA, Patent No. US1192514A.

Gov.uk, 2020. *Guidance Powered Transporters*. [Online] Available at: <https://www.gov.uk/government/publications/powered-transporters/information-sheet-guidance-on-powered-transporters> [Accessed 26 May 2023].



Gov.uk, 2022. *National evaluation of e-scooter trials Findings Report*, London: Gov.uk.

gov.uk, 2023. *The Highway Code, road safety and vehicle rules, electric bike rules*. [Online] Available at: <https://www.gov.uk/electric-bike-rules> [Accessed 26 May 2023].

Greenfleet.net, 2020. *E-cargo bikes for local authorities*. [Online] Available at: <https://greenfleet.net/features/26052020/e-cargo-bikes-local-authorities> [Accessed 19 June 2023].

Hollingsworth_2019_Environ._Res._Lett._14_084031, 2019. *Are e-scooters polluters?* The environmental. Environmental Research Letters, p. 11.

Ian Philips *, J. A. T. C., 2021. *E-bikes and their capability to reduce car CO2 emissions*. The official journal of the World Conference on Transport Research Society (WCTRS), p. 13.

Iftakhar, C., 2020. *Are E-Scooters Suitable for UK Roads? The Pothole Test for Safe Scooter Design*. [Online] Available at: <https://swiftyscooters.com/blogs/journal/e-scooter-safety-and-design> [Accessed 19 June 2023].

Inho Kim, W. J. a. H. Y., January 18, 2017. *Design of a transformable mobile robot for enhancing mobility*. *International Journal of Advanced Robotic Systems*, p. 14.

International Air Transport Association, 2023. *2023 Lithium Battery Guidance Document*. [Online] Available at: <https://www.iata.org/contentassets/.../lithium-battery-guidance-document.pdf>

International Organization for Standardization, 2020. *ISO/TS 4210-10:2020*. [Online] Available at: <https://www.iso.org/standard/80890.html> [Accessed 19 June 2023].

Legislation.gov.uk, 1983. *The Electrically Assisted Pedal Cycles Regulations 1983*. [Online] Available at: <https://www.legislation.gov.uk/uksi/1983/1168/contents/made>

Legislation.gov.uk, 2015. *The Electrically Assisted Pedal Cycles (Amendment) Regulations 2015*. [Online] Available at: <https://www.legislation.gov.uk/uksi/2015/24/contents/made>

Legislation.gov.uk, 2022. *Climate Change Act (Northern Ireland) 2022*. [Online] Available at: <https://www.legislation.gov.uk/nia/2022/31/enacted> [Accessed 19 June 2023].

Local Government Association, 2023. *Shared micromobility within the UK*. [Online] Available at: <https://www.local.gov.uk/publications/shared-micromobility-within-uk> [Accessed 19 June 2023].

London Fire Brigade, 2023. *charging-electric-bike-and-electric-scooter-lithium-batteries*. [Online] Available at: <https://www.london-fire.gov.uk/safety/lithium-batteries/charging-electric-bike-and-electric-scooter-lithium-batteries/> [Accessed 19 June 2023].

Manchester City Council, 2021. *City Centre Transport Strategy to 2040*, Manchester: Manchester City Council.

Manchester City Council, 2022. *eBikes come to Manchester as ambitious city-wide scheme launches*. [Online] Available at: https://www.manchester.gov.uk/news/article/8931/ebikes_come_to_manchester_as_ambitious_city-wide_scheme_launches [Accessed 19 June 2023].

Mintel Group Limited, 2022. *E-mobility: Electric Bikes and Scooters – UK – 2022*, London: Mintel Group Limited.

Mintel Group Limited, 2022. *E-mobility: Electric Bikes and Scooters – UK – 2022*, s.l.: Mintel Group Limited.

Mintel, 2019. *On your e-bike: 14% of UK cyclists intend to buy an e-bike in the next year*. [Online] Available at: <https://www.mintel.com/press-centre/on-your-e-bike-14-of-uk-cyclists-intend-to-buy-an-e-bike-in-the-next-year/> [Accessed 26 May 2023].

Moveelectric.com, 2023. *Paris Residents Vote Ban on Rental E-scooters*. [Online] Available at: <https://www.moveelectric.com/e-scooters/paris-residents-vote-ban-rental-e-scooters> [Accessed 19 June 2023].

National Fire Chiefs Council (NFCC), 2022. *E-bikes and e-scooters fire safety guidance*. [Online] Available at: <https://www.nationalfirechiefs.org.uk/E-bikes-and-e-scooters-fire-safety-guidance> [Accessed 26 May 2023].

Office for Product Safety and Standards, 2022. *Office for Product Safety and Standards Delivery Report 2021/2022*, London: OPSS.

Scottish Government, 2019. *Scotland to become a net-zero society*. [Online] Available at: <https://www.gov.scot/news/scotland-to-become-a-net-zero-society/> [Accessed 19 June 2023].

SHEPHEARD, M., 2020. *UK Net Zero Target*. [Online] Available at: <https://www.instituteforgovernment.org.uk/article/explainer/uk-net-zero-target> [Accessed 19 June 2023].

Shimano, 2022. *State of the Nation Report*, s.l.: Shimano.

The London Borough of Camden Council, 2022. *Camden launches OurBike cargo bike scheme*. [Online] Available at: <https://news.camden.gov.uk/camden-launches-ourbike-cargo-bike-scheme/> [Accessed 19 June 2023].

The Parliamentary Advisory Council for Transport Safety (PACTS), 2022. *the-safety-of-private-e-scooters-in-the-uk-pacts-research*, London: PACTS.

The Parliamentary Advisory Council for Transport Safety (PACTS), 2023. *PACTS and ETSC set out safety recommendations for e-scooters and their riders*, London: PACTS.

Transport For London, 2023. *electric scooter rental trial*. [Online] Available at: <https://tfl.gov.uk/modes/driving/electric-scooter-rental-trial> [Accessed 19 June 2023].

Transport for London, 2023. *TfL announces safety ban of e-scooters on transport network*. [Online] Available at: <https://tfl.gov.uk/info-for/media/press-releases/2021/december/tfl-announces-safety-ban-of-e-scooters-on-transport-network> [Accessed 31 May 2023].

UK Energy Research Centre, 2021. *Cycling is ten times more important than electric cars for reaching net-zero cities*. [Online] Available at: <https://ukerc.ac.uk/news/cycling-is-ten-times-more-important-than-electric-cars-for-reaching-net-zero-cities/> [Accessed 19 June 2023].

UK Government, 1983. *The Electrically Assisted Pedal Cycles Regulations 1983*, London: s.n.

UK Government, 2015. *The Electrically Assisted Pedal Cycles (Amendment) Regulations 2015*, London: s.n.

UK Government, 2023. *Electric bikes: licensing, tax and insurance*. [Online] Available at: <https://www.gov.uk/electric-bike-rules> [Accessed 31 May 2023].

Walthamstow Coroner's Court, 2022. Fatima Abukar: *Prevention of future deaths report*, London: Walthamstow Coroner's Court.

Welsh Government, 2021. *Wales commits to net zero by 2050, but sets out ambitions to get there sooner*. [Online] Available at: <https://www.gov.wales/wales-commits-net-zero-2050-sets-out-ambitions-get-there-sooner> [Accessed 31 May 2023].

Zurich, 2022. *E-bike and e-scooter blazes up 149% sparking Christmas safety warning*. [Online] Available at: <https://www.zurich.co.uk/news-and-insight/fires-sparked-by-e-bikes-and-e-scooters-surge> [Accessed 26 May 2023].



BATTERY BREAKDOWN

WHY ARE E-SCOOTER AND E-BIKE BATTERIES EXPLODING IN PEOPLE'S HOMES AND WHAT CAN BE DONE ABOUT IT?



**Electrical
Safety First**

Powering change +
saving lives.

Electrical Safety First
45 Great Guildford Street
London SE1 0ES



Email - enquiries@electricalsafetyfirst.org.uk

Registered Charity (England and Wales) No. 257376
(Scotland) No. SC039990

© Reissued September 2024

First published in 2023 by Electrical Safety First (ESF)©
Contributors (unless otherwise stated): Photos - © Electrical Safety First, Adobe Stock, Flickr, Pixabay. Layout design and illustrations by Tilted Design.