



Electrical<sup>®</sup>  
Safety  
Professional

BEST PRACTICE GUIDE

# SAFE ISOLATION

Guidance on the management of electrical safety and safe isolation procedures for low voltage installations

# 2

ISSUE 4.2



[electricalsafetyfirst.org.uk](http://electricalsafetyfirst.org.uk)



Powering change + saving lives.

Brought to you by Electrical Safety First

# BEST PRACTICE GUIDE 2: ISSUE 4.2

**Electrical Safety First is indebted to the following organisations for their contribution and/or support to the development of this Guide:**



In electronic format, this Guide is intended to be made available free of charge to all interested parties. Further copies may be downloaded from the websites of some of the contributing organisations.

The version of this Guide on the Electrical Safety First website ([electricalsafetyfirst.org.uk](http://electricalsafetyfirst.org.uk)) will always be the latest.

Feedback on any of the Best Practice Guides is always welcome - email: [enquiries@electricalsafetyfirst.org.uk](mailto:enquiries@electricalsafetyfirst.org.uk)

Electrical Safety First is supported by all sectors of the electrical industry, approvals and research bodies, consumer interest organisations, the electrical distribution industry, professional institutes and institutions, regulatory bodies, trade and industry associations and federations, trade unions, and local and central government.

© *Electrical Safety First. September 2024*

## Published by:

Electrical Safety First  
45 Great Guildford Street, London SE1 0ES  
Email: [enquiries@electricalsafetyfirst.org.uk](mailto:enquiries@electricalsafetyfirst.org.uk)  
Website: [electricalsafetyfirst.org.uk](http://electricalsafetyfirst.org.uk)

Electrical Safety First and other contributors believe that the guidance and information contained in this Best Practice Guide is correct, but all parties must rely on their own skill and judgement when making use of it.

Neither Electrical Safety First nor any contributor assumes any liability to anyone for any loss or damage caused by any error or omission in this Guide, whether such error or omission is the result of negligence or any other cause. Where reference is made to legislation, it is not to be considered as legal advice. Any and all such liability is disclaimed.



The latest versions of all the Best Practice Guides are available from [electricalsafetyfirst.org.uk](http://electricalsafetyfirst.org.uk)



AESM  
[aesm.uk.com](http://aesm.uk.com)



BEAMA  
[beama.org.uk](http://beama.org.uk)



British Gas  
[britishgas.co.uk](http://britishgas.co.uk)



BSI Product Services  
[bsigroup.com](http://bsigroup.com)



City & Guild  
[cityandguilds.com](http://cityandguilds.com)



EAL  
[eal.org.uk](http://eal.org.uk)



ECA  
[eca.co.uk](http://eca.co.uk)



Institution of Engineering and Technology  
[theiet.org](http://theiet.org)



NAPIT  
[napit.org.uk](http://napit.org.uk)



NICEIC  
[niceic.com](http://niceic.com)



SELECT  
[select.org.uk](http://select.org.uk)



SPACES  
[thespaces.org.uk](http://thespaces.org.uk)

# GUIDANCE ON THE MANAGEMENT OF ELECTRICAL SAFETY AND SAFE ISOLATION PROCEDURES FOR LOW VOLTAGE INSTALLATIONS

This Best Practice Guide has been produced in conjunction with the Health and Safety Executive (HSE). Its purpose is to provide practical guidance for employers, employees sub-contractors, and the self-employed on the management of electrical safety, with particular emphasis on low voltage safe isolation procedures to be followed during construction and refurbishment projects, and during maintenance activities.

The guidance is aimed at protecting employees, sub-contractors, and other workers against serious or fatal electrical injuries. Although the principles apply generally, it is particularly relevant to circumstances where work is being carried out in the presence of other trades, and to sites where more than one electrician is employed.



# CONTENTS

1	INTRODUCTION	05
2	LEGISLATION	07
3	HSE GUIDANCE	08
4	SITE SAFETY MANAGEMENT	10
5	SAFE ISOLATION PROCEDURES	13
	SAFE ISOLATION PROCEDURE FLOWCHART	19
6	ADDITIONAL PRECAUTIONS	20
	ANNEX	23



---

# 1. INTRODUCTION

**This Guide explains what needs to be done to make sure workers on site are not exposed to danger when working on or near live electrical systems and equipment in buildings, particularly in the final stages of construction, electrical installation, inspection and testing work.**

Every year, people working on construction sites and on refurbishment and maintenance activities suffer electric shock and burn injuries some of which, tragically, are fatal. Electrical contractors should be aware that many of these accidents are a direct consequence of electricians not implementing safe isolation procedures on AC low voltage installations (that is, those not exceeding 1000 V AC between conductors).

*An example of one such fatal incident is given on page 5.*

Working on extra-low voltage systems (not exceeding 50V AC) may not pose a risk of electrical shock or burns, but it may still cause explosions in the presence of flammable gases.

Experience shows that electricians employed by electrical contractors are particularly at risk of death or serious injury from electric shock or burns if they fail to follow safe working procedures. To achieve compliance with the legislation explained in this Guide, electrical contractors should not allow or condone dangerous work practices and should arrange for the safe working practices explained in the Guide to be implemented diligently.

Whereas this Guide is aimed primarily at electrical contractors and their employees, principal contractors and non-electrical subcontractors have a significant role in managing electrical risks during construction and refurbishment projects.

It should be noted that every electrical operative on a site should be trained in the site safe isolation procedures (see section 5) as a part of their H&S induction before starting work on the site. Other trades and workers on the site should be instructed in electrical safety and how to identify and not to interfere with electrical equipment and isolation equipment as a part of their H&S induction before starting work on a site.

## **Principal contractors**

Principal contractors and their non-electrical subcontractors should make themselves familiar with this Guide to ensure, firstly, that they do not place electrical contractors under pressure to implement unsafe practices; and, secondly, that they understand how their own employees may achieve safety from electrical risks.

## **Electrically Authorised Person**

There must be a responsible chain of authority for any isolation and reenergisation of circuits, with clear delegated authority to issue and cancel permits and stop work in an area if required. This person is usually known as an Authorised Person (AP) and is appointed to control LV operations.

**An example, as detailed by the HSE, of where failure to provide safe isolation caused the death of an electrician, occurred when the supply to a newly installed distribution board was energised prematurely to supply a socket-outlet.**

He was connecting the supply cables to a wall-mounted timer unit, with the line conductor connected to the circuit-breaker at the top left hand side of the busbar assembly. The circuit-breaker had not been securely isolated and was ON as he stripped the insulation from the end of the cable. He touched the live copper conductor of the cable and was electrocuted.

The distribution board was manufactured to a high standard of safety. However, if he needed to energise the board before it was complete, he should first have replaced the cover and switched off and locked the circuit-breakers supplying unfinished or incomplete circuits. He should also have ensured that circuits were not connected into circuit-breakers until they were complete and had been dead tested.

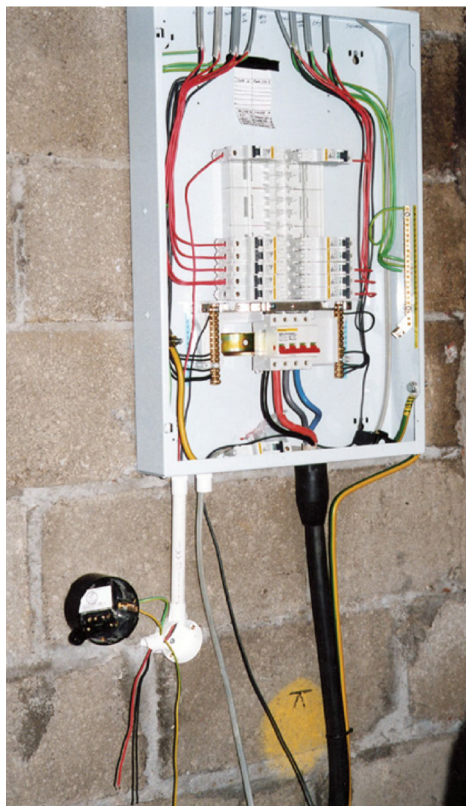



## 2. LEGISLATION

**The Health and Safety at Work etc. Act 1974 sets out the general health and safety duties of employers, employees and the self employed.**

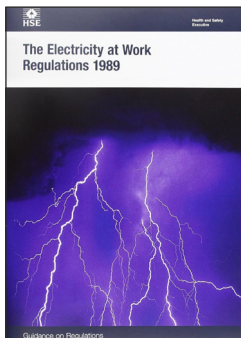

*The Electricity at Work Regulations 1989*, which were made under the Act (*Health and Safety at Work 1974*), require precautions to be taken against the risk of death or personal injury from electricity in work activities.

Duties are placed on employers to ensure, amongst other things, that employees engaged in such work activities on or near electrical equipment\* implement safe systems of work, have the technical knowledge, training or experience to carry out the work safely, and are provided with suitable tools, test equipment and personal protective equipment appropriate to the work they are required to carry out.

Under the Health and Safety at Work etc Act, employees are required to cooperate with their employer to enable the requirements of the regulations to be met. This includes complying with any instructions given on matters such as safe systems of work. The Electricity at Work Regulations 1989 require that employees themselves comply with the regulations.

The Management of Health and Safety at Work Regulations 1999 require employers to make a suitable and sufficient assessment of the risks to the health and safety both of their employees and of other persons arising out of, or in connection with, the conduct of their undertakings. Where five or more persons are employed, the employer must record the significant findings of these risk assessments.

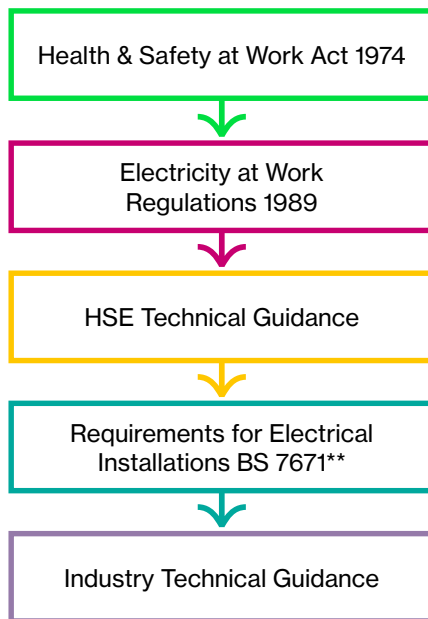

\* EAWR regulation 2 - Interpretation: "electrical equipment" includes anything used or intended to be used or installed for use, to generate, provide, transmit, transform, rectify, convert, conduct, distribute, control, store, measure, or use electrical energy.

\*\* BS 7671:2018+A2:2022+A3:2024.

---

## 3. HSE GUIDANCE

**Generic guidance on safe working practices for work on electrical equipment is published by the Health and Safety Executive (HSE) in its guidance note *Electricity at Work – Safe Working Practices (HSG85)*.**



It provides information on dead and live working and on isolation procedures when working on both Low Voltage (LV) and High Voltage (HV) systems. This Best Practice Guide covers LV systems only and is targeted at the work of electrical contractors, particularly in the construction sector.

Extra precautions need to be taken when working with HV equipment and circuits, and reference should be made to the detailed guidance provided in HSG85 in such circumstances.

*Please note that the following regulations quoted - 12, 13, 14 & 16 are an 'absolute' requirement.*

### Definitions

- Absolute - Regardless of any cost or other consideration.
- Reasonably Practicable - Assess, on the one hand, the magnitude of the risks of the particular work activity or environment and, on the other hand,

the costs in terms of physical difficulty, time trouble, and expense which would be involved in taking steps to eliminate or minimise those risks.

The Health and Safety Executive publication *HSR25 Electricity at Work Regulations 1989 - Guidance on Regulations* is intended to help duty holders meet the requirements of the regulations. It will be of interest and practical help primarily to engineers, technicians and their managers (including those involved in the design, construction, operation or maintenance of electrical systems and equipment).

It sets out the regulations and gives technical and legal guidance on the regulations. Its purpose is to amplify the nature of the precautions in general terms so as to help in the achievement of high standards of electrical safety in compliance with the duties imposed.

In the context of risks arising from live work, regulation 14 of the Electricity at Work Regulations 1989 requires that:

*No person shall be engaged in any work activity on or so near any live conductor (other than one suitably covered with insulating material so as to prevent danger) that danger may arise unless -*

- a. it is unreasonable in all the circumstances for it to be dead; and*
- b. it is reasonable in all the circumstances for him to be at work on or near it while it is live; and*
- c. suitable precautions (including where necessary the provision of suitable protective equipment) are taken to prevent injury.*



It should be noted that all three conditions must be met in order for work on or near live conductors to be carried out.

To comply with regulation 14 of the *Electricity at Work Regulations 1989* (work on or near live conductors), dead working should be the normal method of carrying out work on electrical equipment and circuits.

Live working, which includes not only working on live uninsulated conductors but also working so near to live uninsulated conductors that there is a risk of injury, should only be carried out in circumstances where it is unreasonable to work dead.

Typically, this would include some types of fault finding and testing (including the live testing requirements of *BS 7671 – Requirements for Electrical Installations*), but only where the risks are acceptable and where suitable precautions are taken against injury, including the provision of adequate training and personal protective equipment (PPE).

Pressure to carry out live work is becoming more common in areas such as construction sites, high cost manufacturing and in retail outlets operating twenty-four hours per day, seven days a week.

Irrespective of these pressures, the requirements of the regulations still apply in such situations and live working should only be carried out when justified using the criteria explained in *HSG85*.

For systems where the supply has been isolated and secured to allow dead working, regulation 13 of the *Electricity at Work Regulations 1989* applies as follows:

*Adequate precautions shall be taken to prevent electrical equipment, which has been made dead in order to prevent danger while work is carried out on or*

*near that equipment, from becoming electrically charged during that work if danger may thereby arise.*

This regulation therefore requires that adequate precautions are taken to ensure that conductors and equipment cannot be energised inadvertently while the work is taking place – this is the process of isolation.

*The Electricity at Work Regulations 1989 definition of ‘isolation’ is given in regulation 12: ‘isolation means the disconnection and separation of the electrical equipment from every source of electrical energy in such a way that this disconnection and separation is secure’.*

In effect this means not just cutting off the supply but also ensuring that the means of disconnection is secure, as described in this Guide. In most instances this will require securing the means of disconnection in the OFF position and it is highly recommended that a prohibition sign or label is posted at the point of disconnection as described in this Guide under ‘Safe isolation procedures’.

Of equal importance is regulation 16. This requires that employers ensure that all employees involved in work on electrical equipment are competent.

Employees should be instructed on, and trained in, the implementation of safe systems of work. If they have not received such training and instruction, they should only work under the supervision of a skilled person competent in such works.

---

## 4. SITE SAFETY MANAGEMENT

**It is essential from the outset that effective management and control of the working practices on electrical systems and equipment, particularly in relation to safe isolation procedures, are established and maintained.**

It should be noted that although this Guide is mainly aimed at construction sites, the general principles of management and control also apply to all electrical installation work including refurbishment and maintenance activities.

Duties are placed on directors and managers of companies to ensure the requirements for safe working practices are clearly explained in company-specific electrical safety policy documents including site-specific risk assessments and method statements.

Guidance on how to carry out risk assessments and the form they should take is published by the HSE on its website at [www.hse.gov.uk/risk/index.htm](http://www.hse.gov.uk/risk/index.htm)

All operatives should be shown these documents and have the contents including their responsibilities clearly explained. This can be done during site inductions and/or regular tool-box talks.



Managers should ensure that operatives understand the information regarding safe working practices, particularly where they may not have a good command of English. Having different languages on tag out signage (where required) would be recommended.

All operatives should ensure they have all the required tools, suitable test equipment, personal protective equipment, locking clips, padlocks, keys and prohibition sign and danger notices identified in their risk assessments and method statements.

Appendix B7 of Section B of the *Scottish Joint Industry Board (SJIB) handbook (2017 to 2021)* - <https://sjib.org.uk/handbooks/sjib-handbook/> - requires operatives to provide particular tools and test equipment, including a proprietary test lamp or 2-pole voltage detector, as recommended in *HSE Guidance Note GS 38 Electrical Test Equipment for use on low voltage systems*.

The same rule requires operatives to maintain the items listed in good repair.

For projects where work is being carried out in the presence of other trades, and sites involving more than one electrical operative, it is essential that a suitably experienced and competent person is appointed to oversee the work on site during the construction of the electrical installation.

This appointed person's responsibilities should include the overseeing of the working practices of the operative(s) to ensure that they consistently and

diligently follow the practices set out in the risk assessments and method statements.

*They may also be given responsibility for controlling the work of appointed sub-contractors, who must provide appropriate risk assessments and method statements for their work.*

The appointed person or manager may delegate (in writing) control of specific tasks and procedures to other competent persons who have appropriate training and competence in the performance of these tasks and procedures.

On construction projects, once the electrical installation is nearing completion, ready for inspection and testing, and certainly before energising switchgear, suitable doors should be fitted to all switch-rooms and riser entrances, and heavy duty locks or padlocks fitted accordingly.

Access to these areas should be controlled and restricted to competent persons or persons who are under supervision in accordance with the site electrical safe systems of work.

The access doors should be locked when electrical operatives are not working in these areas and danger notices warning of any live services present posted at all times.



Plant and materials should not be stored in locked electrical switch-rooms or electrical risers.

It is always preferable to avoid energising any outgoing electrical distribution services until the distribution switchgear and all connected circuits are complete and have been inspected and dead-tested in accordance with the requirements of BS 7671.

Before use of any distribution board or circuit, the following should be implemented:

- Access to unused ways should be filled using blanking plates of a suitable type for the distribution board, covers fitted and schedules of circuit details marked up to show the precise status of the installation; and
- Managers should review their risk assessments and method statements and update them as necessary to reflect the changed circumstances. Any changes to working practices should be brought to the attention of the operatives and any other workers at the site who may be affected; and
- No circuit should be energised and put into service until it has been fully completed and inspected and tested in accordance with BS 7671, including checks to ensure that earthing arrangements and protective conductors (including main protective bonding conductors) are in place; and
- Any circuit that is incomplete or has yet to be fully inspected and tested must remain securely isolated from all supply sources.

All workers, supervisors and managers on construction sites should be made aware that it is not considered reasonable to work on or near uninsulated live conductors solely on the grounds of convenience, or of saving time or cost. **This is an 'absolute' requirement of the EAWR - Regulation 14 (see page 8 of this Guide).**

When live services are provided prior to final commissioning and handover, in order to make sure that everyone working on site is aware of any live circuits in an area, danger notices should be displayed on the following items:

- Energised main and sub-main switchgear and distribution boards
- Energised plant
- Exposed cables which are liable to be damaged by other trades or the environmental conditions.



*Additionally, inspection and testing certification - including schedules of circuit details and test results - should be made available at each distribution board.*

People entering completed and energised areas working under instructions from the principal contractor or client's representative must be made aware of the extent of the live services within the respective areas by the electrical contractor, principal contractor or client's representative. They should assume that all services within such areas are energised.

**The electrical contractor** must inform the principal contractor when they intend to complete and energise the electrical installation in an area.

**The principal contractor** must then ensure that the client's representative and all persons on site are informed that the electrical installation in that area has been energised.

**All contractors** should advise their employees of this fact at appropriate site inductions and toolbox talks.

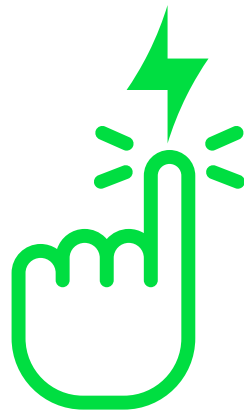

---

# 5. SAFE ISOLATION PROCEDURES

For all work on LV electrical equipment or circuits, it is important to ensure that:

- the correct point of isolation is identified,
- an appropriate means of isolation is used,
- all points of isolation are secured in the off position to prevent any part becoming live unintentionally,
- the supply cannot inadvertently be reinstated while the work is in progress,
- the conductors must be proved to be dead before they are touched,
- a prohibition sign should also be applied at the point(s) of isolation.

In the interests of avoiding inadvertent energisation, best practice would dictate that the point of isolation should be under the control of the person who is carrying out the work on the isolated conductors.

If alternative means of controlling the security of the isolation are adopted, such as the point of isolation being kept under the control of an electrically authorised person, these means should be equally effective at preventing inadvertent reinstatement of the supply.

The means of isolation can be an adjacent local isolation device such as a plug and socket-outlet, fused connection unit, main switch, circuit-breaker, fuse etc, as appropriate, which is under the direct control of the competent person carrying out the work.

**When isolating the main source of energy, it is also essential to isolate any secondary sources (such as standby**

**generators, uninterruptible power supplies and microgenerators).**

**Consideration will also need to be given on the presence of other systems that feed into different parts of the installation - and not just at the main source - such as Photovoltaic (PV) and Electrical Energy Storage Systems (EESS) - see section 6 of this Guide for more information.**

A comprehensive list of devices that are suitable or not suitable for isolation are given in Table 537.4 of BS 7671. Devices that are suitable for isolation can be used without further precautions, provided there is no foreseeable risk that the supply could be reinstated by others, prior to the work being completed by the competent person.

*Note: Circuit-breakers conforming to BS EN 60898 are suitable for isolation and may be marked with the following symbol:*



*However, miniature circuit-breakers (MCBs) manufactured to earlier standards (such as BS 3871) are unlikely to be suitable for isolation.*

Switchgear conforming to BS EN 60947-3 and circuit-breakers and RCDs conforming to BS EN 60947-2 are suitable for isolation, if marked with the symbol shown above.

*Note: A semiconductor is not an isolator.*

*See Annex 1 for further guidance on the identification of devices suitable for isolation.*

Where there is no such local means of isolation or where there is a risk of reinstatement of the supply, the circuit or equipment to be worked on should be securely isolated by one of the following methods:

### Isolation using a main switch



Isolation of equipment or circuits using the main switch is the preferred method.

*BS 7671 Regulation 462.1.201 'A main switch intended for operation by ordinary persons, e.g. of a household or similar installation, shall interrupt both live conductors of a single-phase supply'*

The point of isolation should be locked off using an appropriate safety lock and key retained by the person carrying out the work or the electrically authorised person, and a prohibition sign attached to the point of isolation.

Additional precautions and prohibition signs are required where live parts could be inadvertently accessed where a consumer unit cover has been removed, and the incoming supply conductors to the consumer unit main switch remain live.

Where more than one operative is working on circuits supplied from an

isolated distribution board, a multi-lock hasp with individual safety locks can be used to prevent operation of the main isolator until such time that all persons working on the installation have



completed their work and removed their padlocks from the hasp.

If locking-off facilities are not provided on the relevant switch, then a locked distribution board which prevents access to the main switch is acceptable provided the key is unique and is retained by the person doing the work or the electrically authorised person.

Again, multi-lock hasps with individual safety locks can be used to control the isolation where more than one person is working on the installation. An alternative to a multi-lock hasp in a proprietary key lock box or similar system which provides effective control of access to the key for the point of isolation.

*Note: The use of combination locks is not recommended; they can be inherently insecure as others may know the combination.*



## Isolation of individual circuits protected by circuit breakers

Where suitable circuit-breakers are used as the means of isolation, the relevant device should be locked-off using an appropriate locking-off clip with a padlock which can be opened only by a unique key.

The key should be retained by the person carrying out the work or the electrically authorised person. A prohibition sign should be attached at the point of isolation.



**The practice of placing insulating tape over a circuit-breaker to prevent inadvertent switch-on is not an acceptable means of securing the device in the OFF position. Such unsafe practice will not achieve compliance with the Electricity at Work Regulations 1989.**

*Note: Some distribution boards are manufactured with 'slider switches' to disconnect the circuit from the live side of the circuit-breaker. These devices should not be relied upon as the only means of isolation for circuits, as they do not meet the requirements for isolation and the wrong switch could easily be operated on completion of the work*

## Isolation of individual circuits protected by fuses

Where fuses are used, the removal of the fuse is an acceptable means of disconnecting the supply to an individual circuit for the purpose of isolation.

To prevent the fuse being replaced by others, the fuse should be retained by the person carrying out the work, and a lockable fuse insert with a padlock should be fitted to achieve secure isolation. A prohibition sign should be attached at the point of isolation.



Where lockable inserts are not available, care should be taken to ensure that no 'spare' fuses or fuse carriers are left in the proximity of the distribution board. A prohibition sign should be attached at the point of isolation to deter others replacing the fuse with a spare and energising the circuit, and the following must be considered:

- Where removal of the fuse exposes live terminals that can be touched, a dummy fuse (that is a fuse carrier which is not fitted with a fuse link and which is clearly marked or coloured to make it conspicuous) should be inserted in the fuse way to cover live parts. When this is not possible, the incoming supply to the fuse will need to be isolated.

- A prohibition sign should be attached to deter inadvertent replacement of a spare fuse
- In addition, if possible, the fuseboard door or cover should be locked to prevent access as advised above under 'Isolation using a main switch or distribution board switch disconnecter'.

### **Temporary disconnection of the incoming supply**

For some types of work on existing installations, such as the replacement of main switchgear and consumer units, it is necessary for the distributor's service fuse(s) to be withdrawn in order to disconnect the incoming supply for the purpose of isolation.

Legally, service fuses can be withdrawn only by the electricity supplier or distributor, or by those they have expressly authorised to carry out such work - such as a **'Safe Isolation Provider' (SIP)** - <https://www.dcusa.co.uk/2023/03/safe-isolationprovider-sip-party-accession-applicationsopen/>

In TT systems, the incoming neutral conductor cannot reliably be regarded as being at Earth potential. This means that for TT supplies, a multi-pole switching device, which disconnects the line and neutral conductors, must be used as the means of isolation.

For similar reasons, in IT systems, all poles of the supply must be disconnected. In these circumstances, single-pole isolation, such as by fuses or single-pole circuit-breakers, is not acceptable.

### **Temporary disconnection of circuits**

If any items required for carrying out the procedures recommended are not manufactured for the distribution board in question - or cannot be obtained through retail/trade outlets - it is acceptable to disconnect the circuit from the distribution board, provided that the disconnected conductors are made safe by being coiled and the conductors insulated or otherwise protected against inadvertent reenergisation and would require proving dead before starting work.

Suitable labelling of the disconnected conductors using a prohibition sign is vital to prevent the supply being reinstated, particularly if other electricians are present.

Work carried out inside a live distribution board, such as disconnecting a circuit for isolation, is classed as live working when there is access to exposed live conductors. In this case, the appropriate precautions should be taken as described in HSG85 with respect to regulation 14 of the Electricity at Work Regulations.

*Note: Particular precautions are needed when the point of isolation is only singlepole as there may be presence of borrowed neutrals - see page 19 for further information.*

## Electrical permits-to-work

An electrical permit-to-work can be useful in certain situations for LV work, such as where there is more than one source of supply.

These permits are primarily a statement that a circuit or item of equipment is isolated and has been made safe to work on. They must not be used for live working as this can cause confusion.

Details on the use of these permits, including an example form (see below), are given in **HSG85**: <https://www.hse.gov.uk/pubns/books/hsg85.htm>

Health and Safety  
Executive

Appendix: Typical example of an electrical permit-to-work

**1 Issue**

To \_\_\_\_\_ in charge of this work.

I hereby declare that the following low-voltage apparatus in the area specified is dead, isolated from all live conductors and is connected to earth:

\_\_\_\_\_

\_\_\_\_\_

**Treat all other apparatus and areas as dangerous**

The apparatus is efficiently connected to EARTH at the following points:

\_\_\_\_\_

\_\_\_\_\_

The points of isolation are:

\_\_\_\_\_

\_\_\_\_\_

CAUTION NOTICES have been posted at the following points:

\_\_\_\_\_

\_\_\_\_\_

SAFETY LOCKS have been fitted at the following points:

\_\_\_\_\_

\_\_\_\_\_

The following work is to be carried out:

\_\_\_\_\_

\_\_\_\_\_

**Diagram**

Signed \_\_\_\_\_ Time \_\_\_\_\_ Date \_\_\_\_\_ Permit-to-work (strong)

Electricity at work: Safe working practices

## Prohibition signs

In all instances where there is any risk that the supply could be reinstated, a prohibition sign should be placed at the point of installation. For distribution boards with 'multiple isolations', a single suitable worded sign on each distribution board, such as the example shown, would suffice.

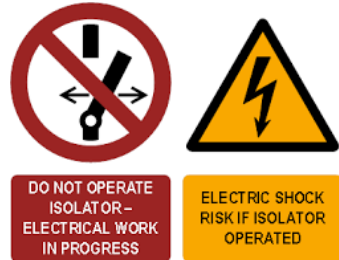

## Proving dead isolated equipment or circuits

It is important to ensure that the correct point of isolation is identified before proving dead.

Where possible and safe to do so, this may include testing with the isolating device first in the ON position, and then in the OFF position to establish that the equipment or circuit is under the control of that device.

Following isolation of equipment or circuits and before starting work it should be proved that the parts to be worked on, and those nearby, are dead.

**It should never be assumed that equipment is dead because a particular isolation device has been placed in the OFF position.**

The procedure for proving dead should be by use of a proprietary test lamp or two-pole voltage detector as recommended in HSE Guidance Note GS38, Electrical test equipment for use on low voltage electrical systems: <https://www.hse.gov.uk/pubns/books/gs38.htm>



The test lamp or voltage detector should be proved to be working on a compatible proprietary proving unit, or a known live source, or an in-built test function before and after use.

It can be argued that the use of a proving unit lessens exposure to live parts and hence improves safety. In simple terms, a proving unit provides a 'stepped up' voltage from a battery to confirm the means of indication (lamps, neons or similar) of a voltage indicator.

**All line, neutral and protective conductors of the circuit/equipment should be checked, verified and proved to be dead.**

Electricians who regularly work on installations that have been energised must have devices for proving that conductors are dead.

**The use of multimeters, makeshift devices and non-contact voltage indicators (voltage sticks) is not advised for voltage detection as such use has caused accidents.**



### HSE Guidance Note GS38

This guidance provides advice on the selection and use of:

- test probes;
- leads;
- lamps;
- voltage detecting devices; and
- measuring equipment;

for circuits with rated voltages not exceeding 1000V AC.

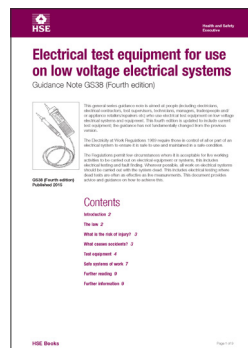

# SAFE ISOLATION PROCEDURE FLOWCHART

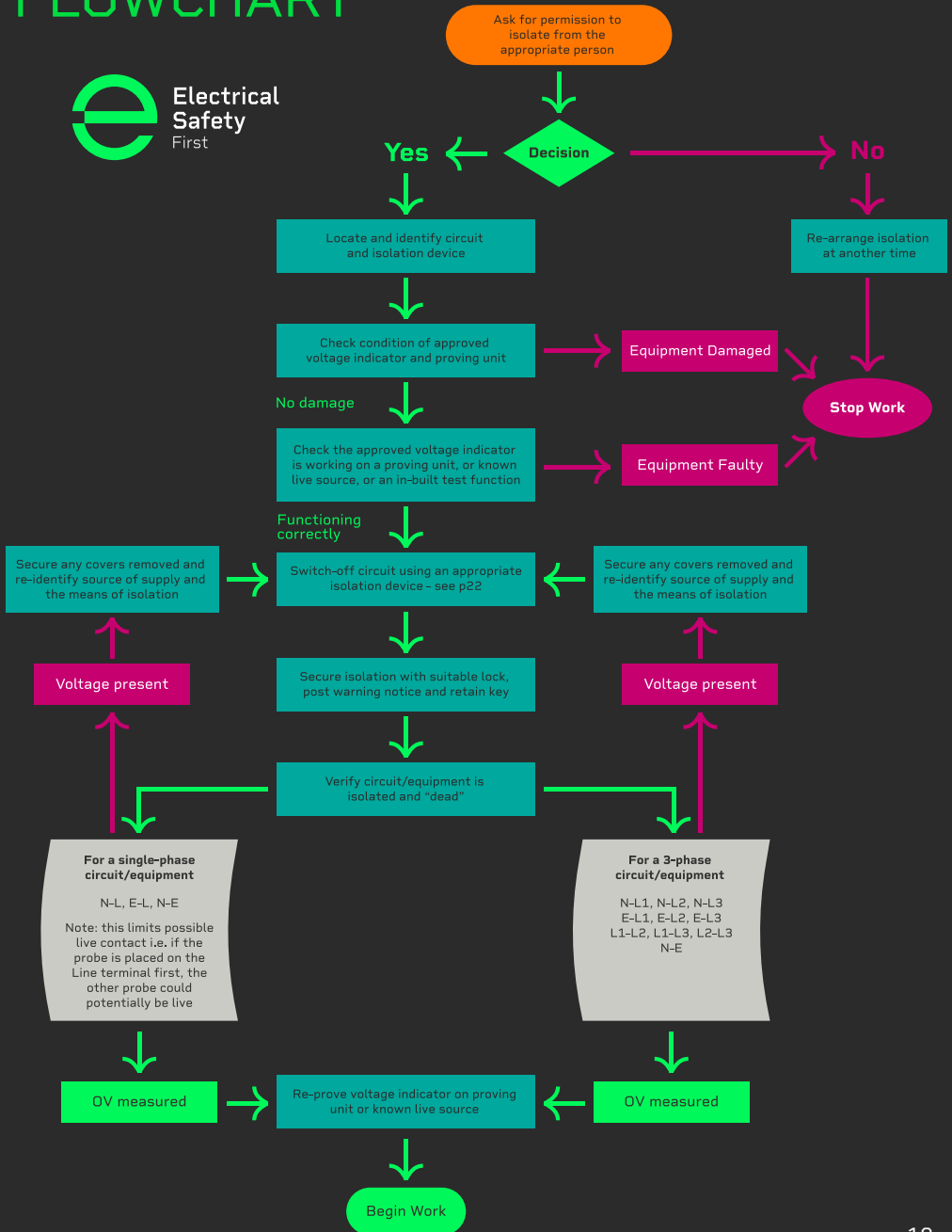

# 6. ADDITIONAL PRECAUTIONS

## New installations

New installations can be a particular hazard as some of the circuits or equipment may need to be modified after the installation has been energised.

It is therefore important that every protective device is correctly identified at each distribution board before any energising takes place, and safe isolation procedures, such as locking-off circuitbreakers as described above, are adopted, particularly where a number of electricians or other trades are working in the same installation.

## Alterations and additions

Alterations and additions to existing installations can also be particularly hazardous. Records including circuit identification may not be available, or may be inadequate or incorrect. It is therefore particularly important to ensure that circuits to be worked on have been correctly identified for isolation purposes prior to work commencing.

## Circuits under automatic control

It is particularly important to correctly identify circuits for isolation purposes if they are under automatic control, such as by time switch or photocell.

Deaths and injuries have occurred where circuits have been proved to be dead at the point of work before work commenced, only for the circuits to be energised unexpectedly by automatic controls as work was underway - **See also: *Mobile apps/remote controls on page 21.***

## Neutral conductor

Care should be taken when working on neutral conductors of circuits, particularly where single-pole isolation is used. The practice of 'borrowing' neutrals, that is using the neutral of one circuit as the neutral for another circuit, is not permitted by *BS 7671*. This dangerous practice, however, is common.

Lighting and control circuits are the most common examples of where this practice is found. In these circumstances, the neutral conductor can become live when it is disconnected, if an energised load on another circuit is connected to it.

It is also difficult to identify specific neutral conductors in 'bunches' of single core cables, such as where enclosed in trunking or conduit, and care should be taken when severing such cables that the correct conductor has been identified.

If doubt exists, live working measures, such as the use of eye protection, electricians' insulating gloves and insulated tools, should be employed until the circuit has been proved to be dead.

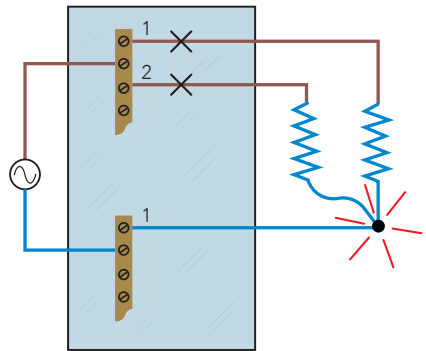



## Additional sources of supply

With prosumer's electrical installations and the spread of embedded generation, many installations previously classed as 'simple installations' have multiple points of isolation.

Therefore, it is not uncommon for there to be an additional source of supply in some installations. For example, there may be presence of a grid connected Solar Photovoltaic System (PV), generators, uninterruptible power supplies (UPS) and/or battery storage.

In such cases, all sources of supply would need to be safely isolated before any work on the installation, circuit and/or equipment is carried out.

Particular care and attention needs to be given to any PV or battery storage systems with 'island mode' capability, (and also UPS systems) that - unless the relevant inverter is also isolated from the DC battery - the AC circuits may remain energised.

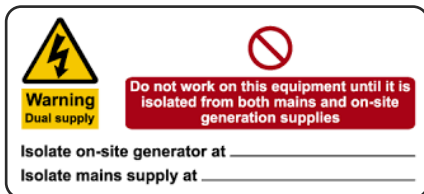

## Proving dead unused or unidentified cables

Where there is uncertainty regarding isolation when removing unidentified cables or proving dead an 'unused' cable, particularly where insufficient conductor is exposed to enable the use of test probes, those conductors should be assumed to be live until positively proven to be dead, and using suitable PPE, any work carried out on them should employ live working practices until the conductors are proved to be dead, and isolated.

If the cable cores are accessible, a clamp meter can be used as a means of identifying a cable by testing for current flow in the conductors. If the cores are not accessible, cable detection equipment may be used in conjunction with a signal generator.

Non-contact voltage indicators (voltage sticks) can also be useful in these situations to make a preliminary test for presence of voltage where cables without a metallic sheath are to be identified. If a non-contact indicator shows a cable to be live, it may be assumed to be so. However, if it does not, the cable must not be assumed to be dead on the basis of such a check alone.

After safe isolation, once insulation is removed to reveal the underlying conductors, as an additional measure a contact voltage detector should be used as the means of proving that the conductors are dead.

## Diverted neutral currents

On some electrical supply systems, diverted neutral currents may originate from another installation, and so may be present even if the installation is isolated.

Forming part of the safe isolation procedure, the use of a suitable clamp meter and a noncontact voltage indicator\* should be used to check for any voltage and current present on the main earthing conductor, main equipotential bonding conductors, exposed and/or extraneous conductive parts present within the installation.

If any diverted neutral currents are identified, this will have to be reported to the local distribution network operator (DNO) immediately by calling 105.



Further guidance on diverted neutral currents - and the prospective dangers - can be found in IET Guidance Note 3: Inspection & Testing 9th Edition: <https://shop.theiet.org/guidance-note-3-inspection-testing-9th-edition> Plus an article by the IET on broken PEN conductors here: <https://electrical.theiet.org/wiring-mattersyears/2021/84-march-2021/broken-pen/>

*\*A non-contact voltage indicator is only suitable to be used in this scenario because the usual instrument (2-pole voltage indicators) are not suitable in this case.*

## Mobile apps/remote controls

App and web based control systems for items such as heating systems, smart lighting and controls of socket-outlet points, need to be considered when safely isolating a circuit and/or equipment, as these items may not fully be isolated whilst the controls are in use/available.



## Protective conductors

Protective conductors of circuits having high protective conductor currents are effectively live, and should be treated with caution.

Significant protective conductor currents can be present in both power and lighting circuits: <https://electrical.theiet.org/wiring-mattersyears/2022/93-november-2022/highprotective-conductor-currents-in-electricalinstallations/>

# ANNEX 1

## Identification of devices which can be used for isolation

Table 537.4 of BS 7671, by kind permission of the Institution of Engineering and Technology.

Device	Standard	Isolation (4)	Emergency switching off (2)	Functional switching (5)
<b>Switching device</b>	BS EN 50428	No	No	Yes
	BS EN 60669-1	No	No	Yes
	BS EN 60669-2-1	No	No	Yes
	BS EN 60669-2-2	No	No	Yes
	BS EN 60669-2-3	No	No	Yes
	BS EN 60669-2-4	Yes(3)	Yes	Yes
	BS EN 60947-3	Yes(1,3)	Yes	Yes
	BS EN 60947-5-1	No	No	Yes
<b>Contactors</b>	BS EN 60947-4-1	Yes(1)	Yes	Yes
	BS EN 61095	No	No	Yes
<b>Starters</b>	BS EN 60947-4-1	Yes(1)	Yes	Yes
	BS EN 60947-4-2	No	No	Yes
	BS EN 60947-4-3	No	No	Yes
<b>Circuit-breaker</b>	BS EN 60898	Yes(3)	Yes	Yes
	BS EN 60947-2	Yes(1)	Yes	Yes
	BS EN 61009-1	Yes(3)	Yes	Yes

<b>Device</b>	<b>Standard</b>	<b>Isolation (4)</b>	<b>Emergency switching off (2)</b>	<b>Functional switching (5)</b>
<b>RCD</b>	BS EN 60947-2 BS EN 61008 series BS EN 61009 series BS 7288	Yes(1) Yes(3) Yes(3) Yes(3)	Yes Yes Yes No	Yes Yes Yes Yes
<b>Arc fault detection devices</b>	BS EN 62606	Yes(3)	Yes	Yes
<b>Isolating switch</b>	BS EN 60669-2-4 BS EN 60947-3	Yes(3) Yes(1,3)	Yes Yes	Yes Yes
<b>Plug and socket-outlet (≤20A)</b>	BS EN 60309	Yes(3)	No	Yes
<b>Plug and socket-outlet (≤32A)</b>	BS EN 60309	Yes(3)	No	No
<b>Device for the connection of luminaire</b>	BS EN 61995-1	Yes(3)	No	No
<b>Control and protective switching device for equipment (CPS)</b>	BS EN 60947-6-1 BS EN 60947-6-2	Yes(1,3) Yes(1,3)	Yes Yes	Yes Yes
<b>Fuse (removal of fuse link)</b>	BS 88 series BS 3036	Yes Yes	No No	No No
<b>Device with semiconductors</b>	BS EN 50428 BS EN 60669-2-1	No No	No No	Yes Yes
<b>Luminaire Supporting Coupler</b>	BS 6972	Yes(3)	No	No
<b>Plug and unswitched socket-outlet</b>	BS 1363-1 BS 1363-2	Yes(3) Yes(3)	No No	Yes Yes
<b>Plug and switched socket-outlet(6)</b>	BS 1363-1 BS 1363-2	Yes(3) Yes(3)	No No	Yes Yes
<b>Plug and unswitched socket-outlet</b>	BS 546	Yes(3)	No	Yes

<b>Device</b>	<b>Standard</b>	<b>Isolation (4)</b>	<b>Energy switching off (2)</b>	<b>Functional switching (5)</b>
<b>Switched fused connection unit</b>	BS 1363-4	Yes(3)	Yes	Yes
<b>Unswitched fused connection unit</b>	BS 1363-4	Yes(3) (Removal of fuse link)	No	No
<b>Cooker Control Unit switch</b>	BS 4177	Yes(3)	Yes	Yes

Yes= Function provided, No= Function not provided

(1) Function provided if the device is suitable and marked with the symbol for isolation (see IEC 60617

identity number S00288)

(2) See Regulation 537.3.3.

(3) Device is suitable for on-load isolation, i.e. disconnection whilst carrying load current.

(4) In an installation forming part of a TT or IT system, isolation requires disconnection of all the live

conductors. See Regulation 462.2.

(5) Circuit-breakers, AFDDs and RCDs are primarily circuit protective devices and, as such, they are

not intended for frequent load switching. Infrequent switching of circuit-breakers on-load is admissible

for the purposes of isolation or emergency switching. For a more frequent duty, the number of operations

and load characteristics according to the manufacturer's instructions should be taken into account or an alternative device from those listed as suitable for functional switching in Table 537.4 should be employed.

(6) The switch of a socket-outlet is not required to be suitable for isolation, as isolation is achieved by

withdrawal of the plug. See Regulation 537.1.3.

NOTE 1: An entry of (1,3) means that the device is suitable for on-load isolation only if it is marked with the symbol for on-load isolation

NOTE 2: In the above table, the functions provided by the devices for isolation and switching are summarized, together with an indication of the relevant product standards.

# NOTES:

A series of horizontal dotted lines for writing notes.



# NOTES:

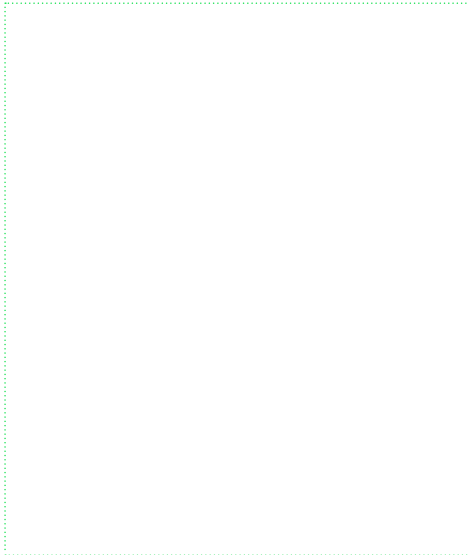
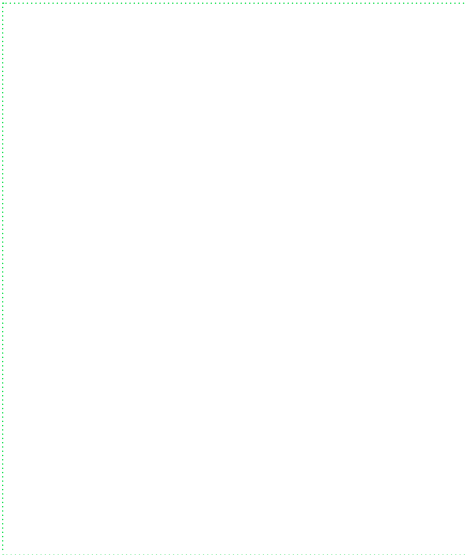
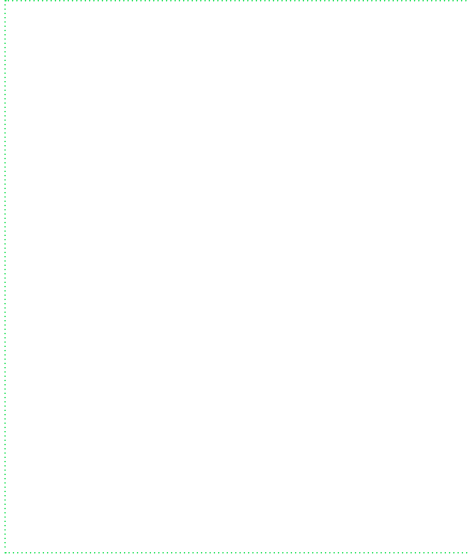
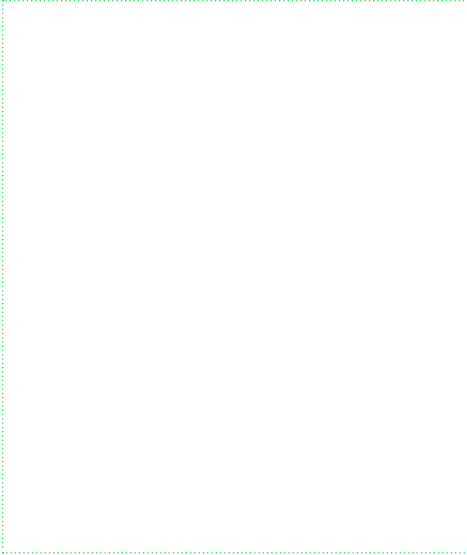



**Electrical<sup>®</sup>  
Safety**  
Professional

Electrical Safety First is the UK charity dedicated to reducing deaths and injuries caused by electrical accidents. Our aim is to ensure everyone in the UK can use electricity safely.

Electrical Safety First  
45 Great Guildford Street,  
London, SE1 0ES

[electricalsafetyfirst.org.uk](http://electricalsafetyfirst.org.uk)  
[enquiries@electricalsafetyfirst.org.uk](mailto:enquiries@electricalsafetyfirst.org.uk)

Registered Charity (England and Wales)  
No. 257376  
(Scotland) No. SC039990

The latest versions of all the Best Practice Guides are available from [electricalsafetyfirst.org.uk](http://electricalsafetyfirst.org.uk)

